

## CONTENT

<b>BASIC</b>	2
<b>EASY</b>	6
<b>BLIND</b>	8
<b>COVER</b>	10
<b>OUTLINE</b>	12
<b>MILD</b>	14
<b>SOFT</b>	16
<b>LIGHT</b>	18
PANNELLI DI RIVESTIMENTO / WALL COVERINGS	20
RAMPA DI ACCESSO / ACCESS RAMP	22
PILETTA / DRAINS	24
COPRPILETTA / DRAIN COVERS	26

# BASIC

PIATTO DOCCIA / SHOWER TRAY



**Piatto doccia completo di griglia copripiletta in acciaio inossidabile. Finitura antibatterica e antiscivolo. Adattabile a tutti gli spazi grazie alla possibilità di realizzare tagli su misura.**

Shower tray complete with stainless steel drain cover grid. Antibacterial and non-slip finish. Adaptable to all spaces thanks to the possibility of making custom cuts.

**Installazione / Installation:**

- In appoggio su pavimento / Resting on the floor.
- A filo pavimento / Flush with the floor.

**Accessori / Accessories:**

- Piletta orizzontale standard H. 54 mm per foro diam. 90 mm / Standard horizontal drain H. 54 mm for hole diam. 90 mm.
- Piletta verticale a richiesta H. 96 mm per foro diam. 90 mm / On request vertical drain H. 96 mm for hole diam. 90 mm.

**Spessore / Thickness:** 3 cm.

**GRIGLIA COPRIPILETTA / DRAIN COVER**



**Un lato acciaio**  
One side steel



**Un lato verniciato**  
One side colored

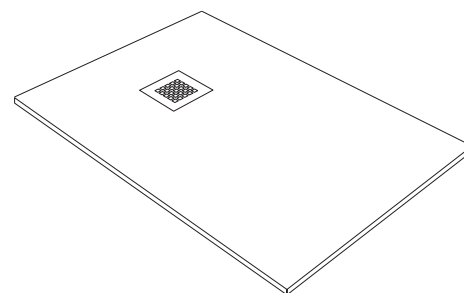

**FINITURE / TEXTURES**



**Pietra / Stone**

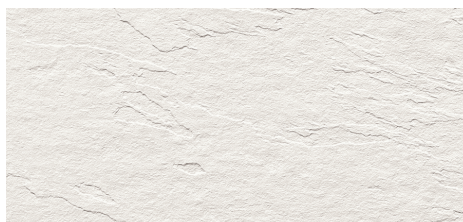

**Ardesia / Slate**

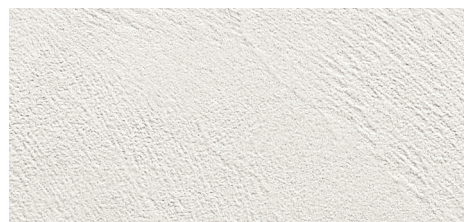

**Cemento / Cement**

**COLORI / COLORS**

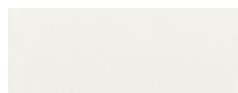

**Bianco / White**

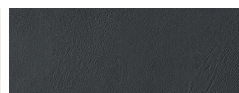

**Antracite / Anthracite**

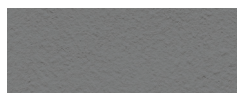

**Grigio / Grey**



**Creta / Clay**



**Tortora / Dove**



**Cenere / Ash**

- DISPONIBILE A MAGAZZINO CON CONSEGNA IN 2 SETTIMANE / AVAILABLE IN STOCK, DELIVERED IN 2 WEEKS.  
CONSEGNA IN 4-5 SETTIMANE PER GLI ARTICOLI NON DISPONIBILI A MAGAZZINO / DELIVERY IN 4-5 WEEKS FOR NO-STOCK ITEM.

## BASIC PIETRA / STONE

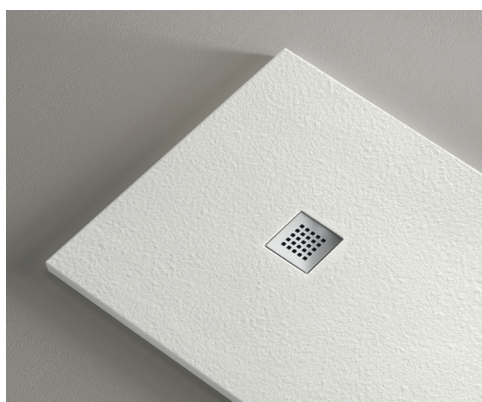

## COLORI / COLORS



DIMENSIONI / DIMENSIONS	PREZZO / PRICE	CODICE / CODE					
90 x 70	403,00	S14577 ●	S14652 ●	S14637 ●	S19125 ●	S20526	S20575
100 x 70	430,00	S14578 ●	S14653 ●	S14638 ●	S19126 ●	S20527	S20576
110 x 70	441,00	S14579 ●	S19089	S19113	S19127	S20528	S20577
120 x 70	458,00	S14580 ●	S14654 ●	S14639 ●	S19128 ●	S20529	S20578
130 x 70	497,00	S14581 ●	S19090	S19114	S19129	S20530	S20579
140 x 70	512,00	S14582 ●	S14655 ●	S14640 ●	S18871 ●	S20531	S20580
150 x 70	538,00	S14583 ●	S19091	S19115	S19130	S20532	S20581
160 x 70	583,00	S14584 ●	S14656 ●	S14641 ●	S18870 ●	S20533	S20582
170 x 70	609,00	S14585 ●	S14657 ●	S14642 ●	S18873 ●	S20534	S20583
180 x 70	684,00	S14586 ●	S18349	S18377	S19131	S20535	S20584
200 x 70	849,00	S14588	S18350	S18378	S19133	S20537	S20586
80 x 80	403,00	S18347 ●	S18351 ●	S18379 ●	S19134 ●	S20538	S20587
90 x 80	414,00	S14589 ●	S19093 ●	S19117 ●	S19135 ●	S20539	S20588
100 x 80	436,00	S14590 ●	S14658 ●	S14643 ●	S19136 ●	S20540	S20589
110 x 80	458,00	S14591 ●	S19094	S19118	S19137	S20541	S20590
120 x 80	477,00	S14592 ●	S14659 ●	S14644 ●	S19138 ●	S20542	S20591
130 x 80	508,00	S14593 ●	S19095	S19119	S19139	S20543	S20592
140 x 80	530,00	S14594 ●	S14660 ●	S14645 ●	S19140 ●	S20544	S20593
150 x 80	565,00	S14595 ●	S19096	S19120	S19141	S20545	S20594
160 x 80	601,00	S14596 ●	S14661 ●	S14646 ●	S18872 ●	S20546	S20595
170 x 80	627,00	S14597 ●	S14662 ●	S14647 ●	S19142 ●	S20547	S20596
180 x 80	750,00	S14598 ●	S18352	S18380	S19143	S20548	S20597
200 x 80	861,00	S14600 ●	S18353	S18381	S19145	S20550	S20599
90 x 90	475,00	S14601 ●	S14663 ●	S14648 ●	S19146 ●	S20551	S20600
100 x 90	508,00	S14602 ●	S18354	S18382	S19147	S20552	S20601
120 x 90	556,00	S14604 ●	S14664 ●	S14649 ●	S19148 ●	S20554	S20603
140 x 90	650,00	S14606 ●	S14665 ●	S14650 ●	S19150 ●	S20556	S20605
160 x 90	728,00	S14608 ●	S14666	S14651	S19152	S20558	S20607
180 x 90	768,00	S14610	S18355	S18383	S19153	S20560	S20609
190 x 90	1036,00	S14611	S19100	S19124	S19154	S20561	S20610
200 x 90	1169,00	S14612 ●	S18356	S18384	S19155	S20562	S20611
100 x 100	557,00	S14613	S18357	S18385	S19156	S20563	S20612
120 x 100	717,00	S14615 ●	S18358	S18386	S19157	S20565	S20614
140 x 100	772,00	S14617 ●	S18359	S18387	S19158	S20567	S20616
160 x 100	849,00	S14619	S18360	S18388	S19159	S20569	S20618
180 x 100	1.103,00	S18348	S18361	S18389	S19160	S20571	S20620
200 x 100	1.213,00	S14621 ●	S18362	S18390	S19161	S20573	S20622

Tutti i prezzi sono espressi in Euro, IVA esclusa / All the prices are expressed in Euro, VAT excluded  
Dimensioni nominali espresse in cm / Nominal dimensions expressed in cm

Piletta non inclusa nel prezzo / Drain not included in the price  
PILETTE / DRAINS\_Pag. 24

## BASIC ARDESIA / SLATE

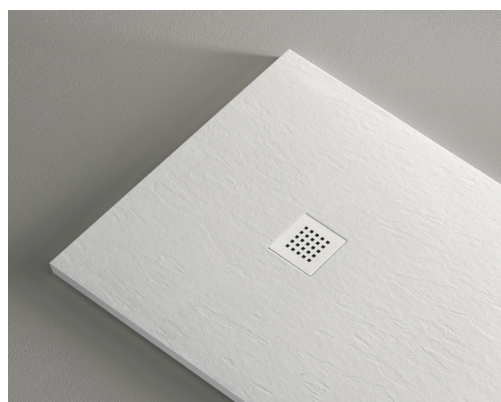

## COLORI / COLORS



DIMENSIONI / DIMENSIONS	PREZZO / PRICE	CODICE / CODE					
90x70	403,00	S18391 ●	S18414	S18460	S19202	S20872	S20910
100x70	430,00	S18392 ●	S18415	S18461	S19203	S20873	S20911
110x70	441,00	S19162	S19172	S19192	S19204	S20874	S20912
120x70	458,00	S18393 ●	S18416	S18462	S19205	S20875	S20913
130x70	497,00	S19163	S19173	S19193	S19206	S20876	S20914
140x70	512,00	S18394 ●	S18417	S18463	S19207	S20877	S20915
160x70	583,00	S18395 ●	S18418	S18464	S19209	S20879	S20917
170x70	585,00	S19514 ●	S19515	S19517	S19518	S20880	S20918
180x70	684,00	S18396	S18419	S18465	S20271	S20881	S20919
80x80	403,00	S18397 ●	S18420	S18466	S19210	S20884	S20922
100x80	436,00	S18398 ●	S18421	S18467	S19212	S20886	S20924
110x80	458,00	S19166	S19176	S19196	S19213	S20887	S20925
120x80	477,00	S18399 ●	S18422	S18468	S19214	S20888	S20926
130x80	508,00	S19167	S19177	S19197	S19215	S20889	S20927
140x80	530,00	S18400 ●	S18423	S18469	S19216	S20890	S20928
150x80	565,00	S19168	S19178	S19198	S19217	S20891	S20929
160x80	601,00	S18401 ●	S18424	S18470	S19218	S20892	S20930
170x80	627,00	S19169 ●	S19179	S19199	S19219	S20893	S20931
180x80	750,00	S18402	S18425	S18471	S19220	S20894	S20932
200x80	861,00	S18403	S18426	S18472	S20272	S20896	S20934
90x90	475,00	S18404 ●	S18427	S18473	S19221	S20897	S20935
120x90	556,00	S18405 ●	S18428	S18474	S19223	S20900	S20938
140x90	650,00	S18406 ●	S18429	S18475	S19225	S20902	S20940
160x90	728,00	S18407	S18430	S18476	S20273	S20904	S20942
180x90	768,00	S18408	S18431	S18477	S20274	S20906	S20944
200x90	1169,00	S18409	S18432	S18478	S20275	S20908	S20946



## BASIC CEMENTO / CEMENT

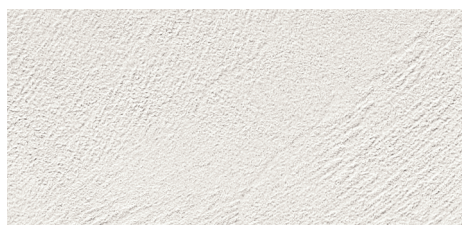
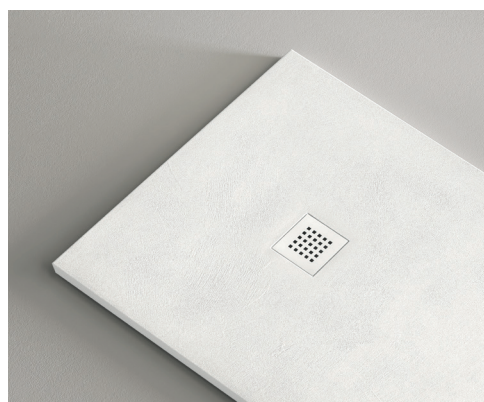

## COLORI / COLORS



DIMENSIONI / DIMENSIONS	PREZZO / PRICE	CODICE / CODE					
90x70	403,00	S18555 ●	S18566	S18588 ●	S19270	S20948	S20986
100x70	430,00	S18556 ●	S18567	S18589 ●	S19271	S20949	S20987
110x70	441,00	S19304	S19318	S19256	S19272	S20950	S20988
120x70	458,00	S18557 ●	S18568	S18590 ●	S19273	S20951	S20989
130x70	497,00	S19305	S19319	S19257	S19274	S20952	S20990
140x70	512,00	S18558 ●	S18569	S18591 ●	S19275	S20953	S20991
160x70	583,00	S18559 ●	S18570	S18592 ●	S19277	S20955	S20993
170x70	609,00	S19307 ●	S19321	S19259 ●	S19278	S20956	S20994
180x70	684,00	S18560	S18571	S18593	S19279	S20957	S20995
200x70	816,00	S18807	S18808	S18810	S19281	S20959	S20997
80x80	387,00	S18811 ●	S18812	S18814 ●	S19282	S20960	S20998
100x80	436,00	S18561 ●	S18572	S18654 ●	S19284	S20962	S21000
110x80	458,00	S19310	S19324	S19262	S19285	S20963	S21001
120x80	477,00	S18562 ●	S18573	S18594 ●	S19286	S20964	S21002
130x80	508,00	S19311	S19325	S19263	S19287	S20965	S21003
140x80	530,00	S18563 ●	S18574	S18595 ●	S19288	S20966	S21004
150x80	565,00	S19312	S19326	S19264	S19289	S20967	S21005
160x80	601,00	S18564 ●	S18575	S18596 ●	S19290	S20968	S21006
170x80	627,00	S19313 ●	S19327	S19265 ●	S19291	S20969	S21007
180x80	750,00	S18565	S18576	S18597	S19292	S20970	S21008
200x80	827,00	S18815	S18816	S18818	S19294	S20972	S21010
90x90	456,00	S18819 ●	S18820	S18822 ●	S19295	S20973	S21011
120x90	534,00	S18827 ●	S18828	S18830 ●	S19297	S20976	S21014
140x90	625,00	S18831 ●	S18832	S18834 ●	S19299	S20978	S21016
160x90	728,00	S19317	S19241	S19269	S19301	S20980	S21018
180x90	768,00	S18835	S18836	S18838	S19302	S20982	S21020
200x90	1.169,00	S21076	S21077	S21078	S21079	S20984	S21022

# EASY

PIATTO DOCCIA / SHOWER TRAY



**Piatto doccia completo di griglia copripiletta in tinta posizionata al centro del piatto. Finitura antibatterica e antiscivolo. Adattabile a tutti gli spazi grazie alla possibilità di realizzare tagli su misura.**

Shower tray complete with stainless steel drain cover grid. Antibacterial and non-slip finish. Adaptable to all spaces thanks to the possibility of making custom cuts.

**Installazione / Installation:**

- In appoggio su pavimento / Resting on the floor.
- A filo pavimento / Flush with the floor.

**Accessori / Accessories:**

- Piletta orizzontale standard H. 54 mm per foro diam. 90 mm / Standard horizontal drain H. 54 mm for hole diam. 90 mm.
- Piletta verticale a richiesta H. 96 mm per foro diam. 90 mm / On request vertical drain H. 96 mm for hole diam. 90 mm.

**Spessore / Thickness:** 3 cm.

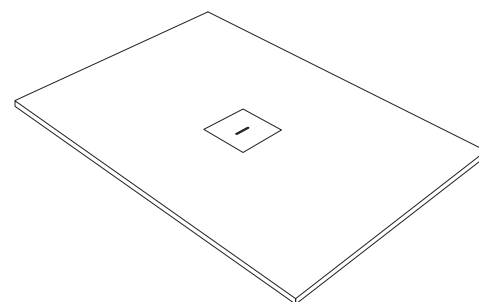

**FINITURE / TEXTURES**

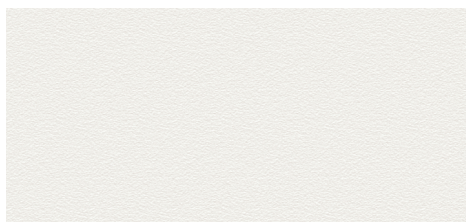

**Velluto / Velvet**

**COLORI / COLORS**

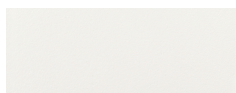

**Bianco / White**

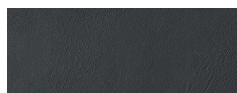

**Antracite / Anthracite**

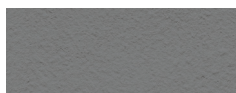

**Grigio / Grey**



**Creta / Clay**



**Tortora / Dove**



**Cenere / Ash**

- DISPONIBILE A MAGAZZINO CON CONSEGNA IN 2 SETTIMANE / AVAILABLE IN STOCK, DELIVERED IN 2 WEEKS.
- CONSEGNA IN 4-5 SETTIMANE PER GLI ARTICOLI NON DISPONIBILI A MAGAZZINO / DELIVERY IN 4-5 WEEKS FOR NO-STOCK ITEM.

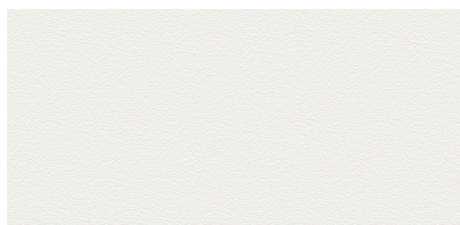
**COLORI / COLORS**

DIMENSIONI / DIMENSIONS	PREZZO / PRICE	CODICE / CODE					
90 x 70	430,00	S18598 ●	S18612	S18640	S20079	S20825	S20848
100 x 70	447,00	S18599 ●	S18613	S18641	S20080	S20826	S20849
120 x 70	507,00	S18600 ●	S18614	S18642	S19315	S20827	S20850
140 x 70	576,00	S18601 ●	S18615	S18643	S20081	S20828	S20851
160 x 70	656,00	S18602 ●	S18616	S18644	S20082	S20829	S20852
180 x 70	839,00	S20276	S20277	S20278	S20279	S20830	S20853
80 x 80	430,00	S18603 ●	S18617	S18645	S19444	S20832	S20855
100 x 80	466,00	S18604 ●	S18618	S18646	S20083	S20834	S20857
120 x 80	536,00	S18605 ●	S18619	S18647	S20084	S20835	S20858
140 x 80	595,00	S18606 ●	S18620	S18648	S20085	S20836	S20859
160 x 80	675,00	S18607 ●	S18621	S18649	S20086	S20837	S20860
180 x 80	844,00	S20070	S20073	S20076	S20087	S20838	S20861
200 x 80	966,00	S19477	S19478	S19480	S19481	S20839	S20862
90 x 90	497,00	S18608 ●	S18622	S18650	S19465	S20840	S20863
120 x 90	626,00	S18609 ●	S18623	S18651	S19470	S20842	S20865
140 x 90	665,00	S18610 ●	S18624	S18652	S19471	S20843	S20866
160 x 90	816,00	S20071	S20074	S20077	S20088	S20844	S20867
180 x 90	864,00	S20072	S20075	S20078	S20089	S20845	S20868
200 x 90	1.302,00	S21072	S21073	S21074	S21075	S20846	S20869
100 x 100	629,00	S18611	S18625	S18653	S20280	S20847	S20870



# BLIND

PIATTO DOCCIA / SHOWER TRAY



**Piatto doccia completo di griglia copripiletta rettangolare in tinta. Finitura antibatterica e antiscivolo. Adattabile a tutti gli spazi grazie alla possibilità di realizzare tagli su misura.**

Shower tray complete with stainless steel drain cover grid. Antibacterial and non-slip finish. Adaptable to all spaces thanks to the possibility of making custom cuts.

**Installazione / Installation:**

- In appoggio su pavimento / Resting on the floor.
- A filo pavimento / Flush with the floor.

**Accessori / Accessories:**

- Piletta rettangolare standard L. 192 mm, P. 47 mm, H. 60 mm / Standard rectangular drain L. 192 mm, P. 47 mm, H. 60 mm.

**Spessore / Thickness:** 3 cm.

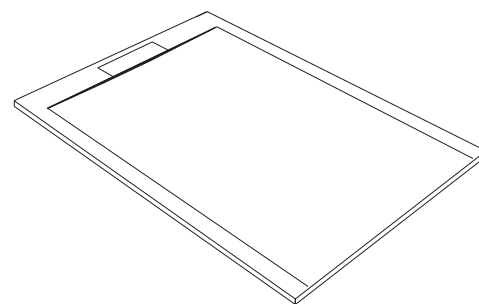

**FINITURE / TEXTURES**



**Pietra** / Stone

**COLORI / COLORS**

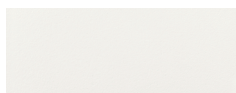

**Bianco** / White

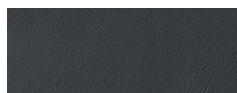

**Antracite** / Anthracite

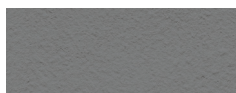

**Grigio** / Grey



**Creta** / Clay



**Tortora** / Dove



**Cenere** / Ash

- DISPONIBILE A MAGAZZINO CON CONSEGNA IN 2 SETTIMANE / AVAILABLE IN STOCK, DELIVERED IN 2 WEEKS.  
CONSEGNA IN 4-5 SETTIMANE PER GLI ARTICOLI NON DISPONIBILI A MAGAZZINO / DELIVERY IN 4-5 WEEKS FOR NO-STOCK ITEM.



**COLORI / COLORS**

DIMENSIONI / DIMENSIONS	PREZZO / PRICE	CODICE / CODE					
100x70	552,00	S20682	S20706	S20730	S20754	S20778	S20802
120x70	607,00	S20684	S20708	S20732	S20756	S20780	S20804
140x70	662,00	S20686	S20710	S20734	S20758	S20782	S20806
100x80	552,00	S20688	S20712	S20736	S20760	S20784	S20808
120x80	618,00	S20690	S20714	S20738	S20762	S20786	S20810
140x80	673,00	S20692	S20716	S20740	S20764	S20788	S20812
160x80	750,00	S20694	S20718	S20742	S20766	S20790	S20814
180x80	871,00	S20696	S20720	S20744	S20768	S20792	S20816
	585,00						
100x90	706,00	S20698	S20722	S20746	S20770	S20794	S20818
120x90	794,00	S20700	S20724	S20748	S20772	S20796	S20820
140x90	904,00	S20702	S20726	S20750	S20774	S20798	S20822
160x90	869,00	S20704	S20728	S20752	S20776	S20800	S20824

# COVER

PIATTO DOCCIA / SHOWER TRAY



**Piatto doccia completo di copripiletta rettangolare in tinta o di griglia acciaio opzionale. Finitura antibatterica e antiscivolo. Adattabile a tutti gli spazi grazie alla possibilità di realizzare tagli su misura.**

Shower tray complete with stainless steel drain cover grid. Antibacterial and non-slip finish. Adaptable to all spaces thanks to the possibility of making custom cuts.

**Installazione / Installation:**

- In appoggio su pavimento / Resting on the floor.
- A filo pavimento / Flush with the floor.

**Accessori / Accessories:**

- Piletta orizzontale standard H. 54 mm per foro diam. 90 mm / Standard horizontal drain H. 54 mm for hole diam. 90 mm.
- Piletta verticale a richiesta H. 96 mm per foro diam. 90 mm / On request vertical drain H. 96 mm for hole diam. 90 mm.

**Spessore / Thickness:** 3 cm.

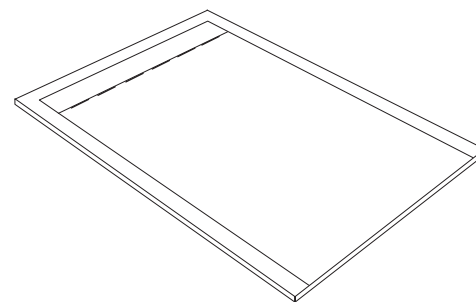

**FINITURE / TEXTURES**



**Pietra** / Stone

**COLORI / COLORS**

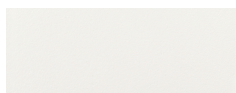

**Bianco** / White

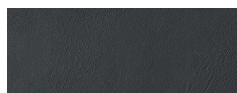

**Antracite** / Anthracite

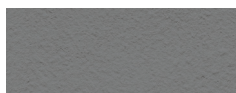

**Grigio** / Grey



**Creta** / Clay



**Tortora** / Dove



**Cenere** / Ash

- DISPONIBILE A MAGAZZINO CON CONSEGNA IN 2 SETTIMANE / AVAILABLE IN STOCK, DELIVERED IN 2 WEEKS.  
CONSEGNA IN 4-5 SETTIMANE PER GLI ARTICOLI NON DISPONIBILI A MAGAZZINO / DELIVERY IN 4-5 WEEKS FOR NO-STOCK ITEM.

**COLORI / COLORS**

DIMENSIONI / DIMENSIONS	PREZZO / PRICE	CODICE / CODE					
100 x 70	552,00	S20185 ●	S20241	S20251	S20261	S20624	S20648
120 x 70	607,00	S20186 ●	S20242	S20252	S20262	S20626	S20650
140 x 70	662,00	S20187 ●	S20243	S20253	S20263	S20628	S20652
100 x 80	552,00	S20188 ●	S20244	S20254	S20264	S20630	S20654
120 x 80	618,00	S20189 ●	S20245	S20255	S20265	S20632	S20656
140 x 80	673,00	S20190 ●	S20246	S20256	S20266	S20634	S20658
160 x 80	750,00	S20191	S20247	S20257	S20267	S20636	S20660
180 x 80	871,00	S20192	S20248	S20258	S20268	S20638	S20662
100 x 90	585,00	S21064	S21066	S21068	S21070	S20640	S20664
120 x 90	706,00	S20225	S20249	S20259	S20269	S20642	S20666
140 x 90	794,00	S20226	S20250	S20260	S20270	S20644	S20668
160 x 90	904,00	S21065	S21067	S21069	S21071	S20646	S20670

**COPRIPILETTA / DRAIN COVER:**

**A - Copripiletta materico incluso.**

Material drain cover.

**B - Griglia acciaio su richiesta.**

Steel grill on demande.





# OUTLINE

PIATTO DOCCIA / SHOWER TRAY



**Piatto doccia completo di griglia copripiletta in acciaio inossidabile. Finitura antibatterica e antiscivolo. Adattabile a tutti gli spazi grazie alla possibilità di realizzare tagli su misura.**

Shower tray complete with stainless steel drain cover grid. Antibacterial and non-slip finish. Adaptable to all spaces thanks to the possibility of making custom cuts.

#### Installazione / Installation:

- In appoggio su pavimento / Resting on the floor.
- A filo pavimento / Flush with the floor.

#### Accessori / Accessories:

- Piletta orizzontale standard H. 54 mm per foro diam. 90 mm / Standard horizontal drain H. 54 mm for hole diam. 90 mm.
- Piletta verticale a richiesta H. 96 mm per foro diam. 90 mm / On request vertical drain H. 96 mm for hole diam. 90 mm.

**Spessore / Thickness:** 3 cm.

#### GRIGLIA COPRIPILETTA / DRAIN COVER



**Un lato acciaio**  
One side steel



**Un lato verniciato**  
One side colored

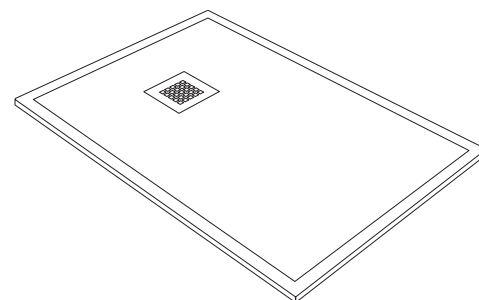

#### FINITURE / TEXTURES



**Pietra / Stone**

#### COLORI / COLORS

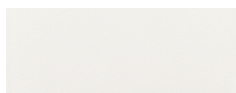

**Bianco / White**

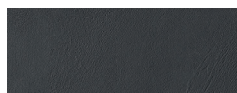

**Antracite / Anthracite**

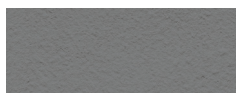

**Grigio / Grey**



**Creta / Clay**



**Tortora / Dove**



**Cenere / Ash**

- DISPONIBILE A MAGAZZINO CON CONSEGNA IN 2 SETTIMANE / AVAILABLE IN STOCK, DELIVERED IN 2 WEEKS.  
CONSEGNA IN 4-5 SETTIMANE PER GLI ARTICOLI NON DISPONIBILI A MAGAZZINO / DELIVERY IN 4-5 WEEKS FOR NO-STOCK ITEM.

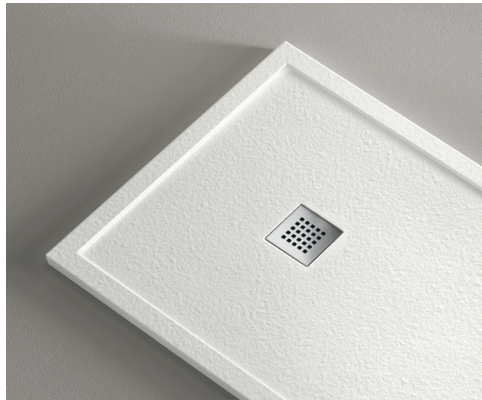

**COLORI / COLORS**

<b>DIMENSIONI / DIMENSIONS</b>	<b>PREZZO / PRICE</b>	<b>CODICE / CODE</b>					
140x70	<b>750,00</b>	<b>S19617</b>	<b>S19629</b>	<b>S19653</b>	<b>S19665</b>	<b>S20671</b>	<b>S20676</b>
100x80	<b>629,00</b>	<b>S19621</b>	<b>S19633</b>	<b>S19657</b>	<b>S19669</b>	<b>S20672</b>	<b>S20677</b>
120x80	<b>728,00</b>	<b>S19622</b>	<b>S19634</b>	<b>S19658</b>	<b>S19670</b>	<b>S20673</b>	<b>S20678</b>
140x80	<b>794,00</b>	<b>S19623</b>	<b>S19635</b>	<b>S19659</b>	<b>S19671</b>	<b>S20674</b>	<b>S20679</b>

# MILD

PIATTO DOCCIA / SHOWER TRAY



**Piatto doccia in Gres completo di copripiletta in tinta. Disponibile in 5 colorazioni diverse. Finitura antibatterica e antiscivolo.**

**Materiale: Laminam®**

Stoneware shower tray complete with matching drain cover. Available in 5 different colors. Antibacterial and non-slip finish.

Material: Laminam®

**Installazione / Installation:**

- In appoggio su pavimento / Resting on the floor.
- A filo pavimento / Flush with the floor.

**Accessori / Accessories:**

- Piletta orizzontale standard H. 54 mm per foro diam. 90 mm / Standard horizontal drain H. 54 mm for hole diam. 90 mm.
- Piletta verticale a richiesta H. 96 mm per foro diam. 90 mm / On request vertical drain H. 96 mm for hole diam. 90 mm.

**Spessore / Thickness: 3 cm.**

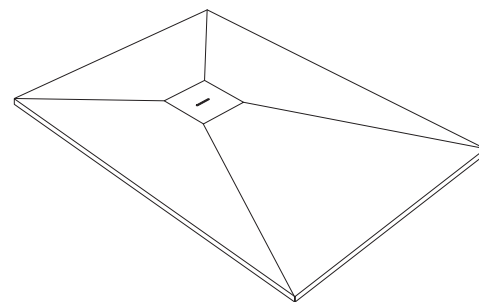

## FINITURE / TEXTURES

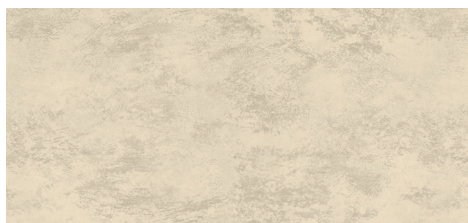

Oxide Avorio



Ossido Bruno



Pietra di Savoia Antracite

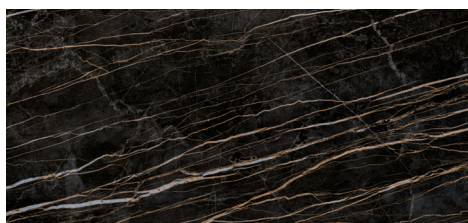

Noir Desir

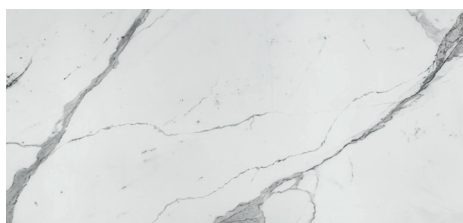

Bianco Statuario venato opaco

● DISPONIBILE A MAGAZZINO CON CONSEGNA IN 2 SETTIMANE / AVAILABLE IN STOCK, DELIVERED IN 2 WEEKS.  
CONSEGNA IN 4-5 SETTIMANE PER GLI ARTICOLI NON DISPONIBILI A MAGAZZINO / DELIVERY IN 4-5 WEEKS FOR NO-STOCK ITEM.

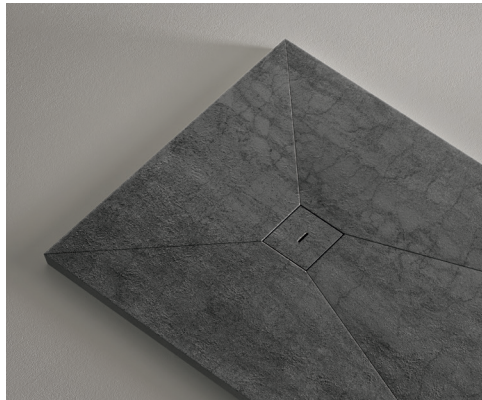



---

**COLORI / COLORS**



Oxide Avorio

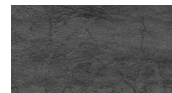
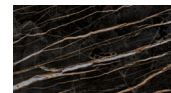

Ossido Bruno

Pietra di Savoia  
Antracite

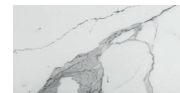
Noir Desir

Bianco Statuario  
venato opaco

<b>DIMENSIONI / DIMENSIONS</b>	<b>PREZZO / PRICE</b>	<b>CODICE / CODE</b>				
100x80	<b>1.091,00</b>	<b>GOA10080</b>	<b>GOB10080</b>	<b>GPA10080</b>	<b>GND10080</b>	<b>GBS10080</b>
120x80	<b>1.158,00</b>	<b>GOA12080</b>	<b>GOB12080</b>	<b>GPA12080</b>	<b>GND12080</b>	<b>GBS12080</b>
140x80	<b>1.290,00</b>	<b>GOA14080</b>	<b>GOB14080</b>	<b>GPA14080</b>	<b>GND14080</b>	<b>GBS14080</b>
160x80	<b>1.422,00</b>	<b>GOA16080</b>	<b>GOB16080</b>	<b>GPA16080</b>	<b>GND16080</b>	<b>GBS16080</b>
180x80	<b>1.555,00</b>	<b>GOA18080</b>	<b>GOB18080</b>	<b>GPA18080</b>	<b>GND18080</b>	<b>GBS18080</b>
200x80	<b>1.687,00</b>	<b>GOA20080</b>	<b>GOB20080</b>	<b>GPA20080</b>	<b>GND20080</b>	<b>GBS20080</b>
120x90	<b>1.257,00</b>	<b>GOA12090</b>	<b>GOB12090</b>	<b>GPA12090</b>	<b>GND12090</b>	<b>GBS12090</b>
140x90	<b>1.390,00</b>	<b>GOA14090</b>	<b>GOB14090</b>	<b>GPA14090</b>	<b>GND14090</b>	<b>GBS14090</b>
160x90	<b>1.522,00</b>	<b>GOA16090</b>	<b>GOB16090</b>	<b>GPA16090</b>	<b>GND16090</b>	<b>GBS16090</b>
180x90	<b>1.654,00</b>	<b>GOA18090</b>	<b>GOB18090</b>	<b>GPA18090</b>	<b>GND18090</b>	<b>GBS18090</b>
200x90	<b>1.792,00</b>	<b>GOA20090</b>	<b>GOB20090</b>	<b>GPA20090</b>	<b>GND20090</b>	<b>GBS20090</b>



# SOFT

PIATTO DOCCIA / SHOWER TRAY



**Piatto doccia in Gres completo di copripiletta rettangolare in tinta. Disponibile in 5 colorazioni diverse. Finitura antibatterica e antiscivolo. Materiale: Laminam®**

Stoneware shower tray complete with matching rectangular drain cover. Available in 5 different colors. Antibacterial and non-slip finish. Material: Laminam®

**Installazione / Installation:**

- In appoggio su pavimento / Resting on the floor.
- A filo pavimento / Flush with the floor.

**Accessori / Accessories:**

- Piletta orizzontale standard H. 54 mm per foro diam. 90 mm / Standard horizontal drain H. 54 mm for hole diam. 90 mm.
- Piletta verticale a richiesta H. 96 mm per foro diam. 90 mm / On request vertical drain H. 96 mm for hole diam. 90 mm.

**Spessore / Thickness:** 3 cm.

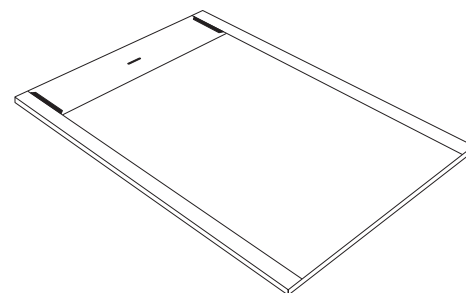

## FINITURE / TEXTURES

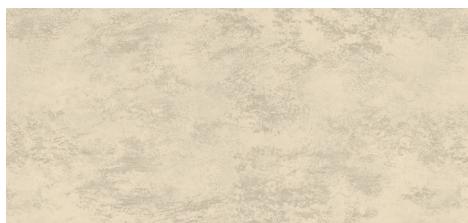

Oxide Avorio



Ossido Bruno



Pietra di Savoia Antracite

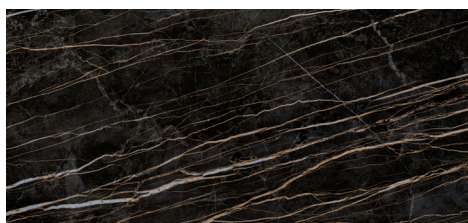

Noir Desir



Bianco Statuario venato opaco

● DISPONIBILE A MAGAZZINO CON CONSEGNA IN 2 SETTIMANE / AVAILABLE IN STOCK, DELIVERED IN 2 WEEKS.  
CONSEGNA IN 4-5 SETTIMANE PER GLI ARTICOLI NON DISPONIBILI A MAGAZZINO / DELIVERY IN 4-5 WEEKS FOR NO-STOCK ITEM.







---

**COLORI / COLORS**



Oxide Avorio

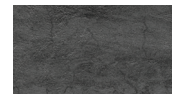
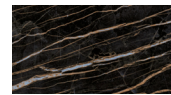

Ossido Bruno

Pietra di Savoia  
Antracite

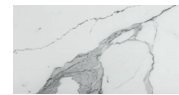
Noir Desir

Bianco Statuario  
venato opaco

DIMENSIONI / DIMENSIONS	PREZZO / PRICE	CODICE / CODE				
100 x 80	1.241,00	GOA10080C	GOB10080C	GPA10080C	GND10080C	GBS10080C
120 x 80	1.285,00	GOA12080C	GOB12080C	GPA12080C	GND12080C	GBS12080C
140 x 80	1.422,00	GOA14080C	GOB14080C	GPA14080C	GND14080C	GBS14080C
160 x 80	1.544,00	GOA16080C	GOB16080C	GPA16080C	GND16080C	GBS16080C
180 x 80	1.666,00	GOA18080C	GOB18080C	GPA18080C	GND18080C	GBS18080C
200 x 80	1.792,00	GOA20080C	GOB20080C	GPA20080C	GND20080C	GBS20080C
120 x 90	1.395,00	GOA12090C	GOB12090C	GPA12090C	GND12090C	GBS12090C
140 x 90	1.517,00	GOA14090C	GOB14090C	GPA14090C	GND14090C	GBS14090C
160 x 90	1.637,00	GOA16090C	GOB16090C	GPA16090C	GND16090C	GBS16090C
180 x 90	1.759,00	GOA18090C	GOB18090C	GPA18090C	GND18090C	GBS18090C
200 x 90	1.880,00	GOA20090C	GOB20090C	GPA20090C	GND20090C	GBS20090C

# LIGHT

PIATTO DOCCIA / SHOWER TRAY



**Piatto doccia in Gres completo di copripiletta rettangolare in tinta. Disponibile in 5 colorazioni diverse. Finitura antibatterica e antiscivolo. Materiale: Laminam®**

Stoneware shower tray complete with matching rectangular drain cover. Available in 5 different colors. Antibacterial and non-slip finish. Material: Laminam®

**Installazione / Installation:**

- In appoggio su pavimento / Resting on the floor.
- A filo pavimento / Flush with the floor.

**Accessori / Accessories:**

- Piletta orizzontale standard H. 54 mm per foro diam. 90 mm / Standard horizontal drain H. 54 mm for hole diam. 90 mm.
- Piletta verticale a richiesta H. 96 mm per foro diam. 90 mm / On request vertical drain H. 96 mm for hole diam. 90 mm.

**Spessore / Thickness:** 3 cm.

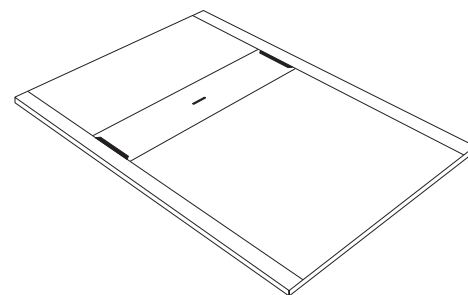

## FINITURE / TEXTURES



Oxide Avorio



Ossido Bruno



Pietra di Savoia Antracite

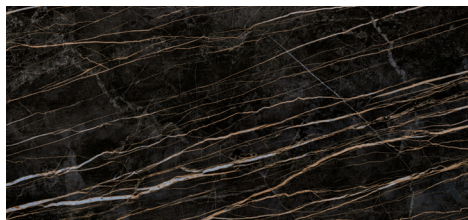

Noir Desir



Bianco Statuario venato opaco

● DISPONIBILE A MAGAZZINO CON CONSEGNA IN 2 SETTIMANE / AVAILABLE IN STOCK, DELIVERED IN 2 WEEKS.  
CONSEGNA IN 4-5 SETTIMANE PER GLI ARTICOLI NON DISPONIBILI A MAGAZZINO / DELIVERY IN 4-5 WEEKS FOR NO-STOCK ITEM.



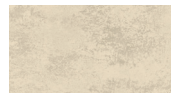

---

**COLORI / COLORS**

Oxide Avorio

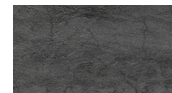
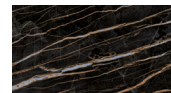

Ossido Bruno

Pietra di Savoia  
Antracite

Noir Desir

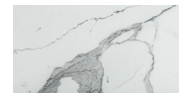
Bianco Statuario  
venato opaco

<b>DIMENSIONI / DIMENSIONS</b>	<b>PREZZO / PRICE</b>	<b>CODICE / CODE</b>				
100 x 80	<b>1.241,00</b>	<b>GOA10080B</b>	<b>GOB10080B</b>	<b>GPA10080B</b>	<b>GND10080B</b>	<b>GBS10080B</b>
120 x 80	<b>1.285,00</b>	<b>GOA12080B</b>	<b>GOB12080B</b>	<b>GPA12080B</b>	<b>GND12080B</b>	<b>GBS12080B</b>
140 x 80	<b>1.422,00</b>	<b>GOA14080B</b>	<b>GOB14080B</b>	<b>GPA14080B</b>	<b>GND14080B</b>	<b>GBS14080B</b>
160 x 80	<b>1.544,00</b>	<b>GOA16080B</b>	<b>GOB16080B</b>	<b>GPA16080B</b>	<b>GND16080B</b>	<b>GBS16080B</b>
180 x 80	<b>1.666,00</b>	<b>GOA18080B</b>	<b>GOB18080B</b>	<b>GPA18080B</b>	<b>GND18080B</b>	<b>GBS18080B</b>
200 x 80	<b>1.792,00</b>	<b>GOA20080B</b>	<b>GOB20080B</b>	<b>GPA20080B</b>	<b>GND20080B</b>	<b>GBS20080B</b>
120 x 90	<b>1.395,00</b>	<b>GOA12090B</b>	<b>GOB12090B</b>	<b>GPA12090B</b>	<b>GND12090B</b>	<b>GBS12090B</b>
140 x 90	<b>1.517,00</b>	<b>GOA14090B</b>	<b>GOB14090B</b>	<b>GPA14090B</b>	<b>GND14090B</b>	<b>GBS14090B</b>
160 x 90	<b>1.637,00</b>	<b>GOA16090B</b>	<b>GOB16090B</b>	<b>GPA16090B</b>	<b>GND16090B</b>	<b>GBS16090B</b>
180 x 90	<b>1.759,00</b>	<b>GOA18090B</b>	<b>GOB18090B</b>	<b>GPA18090B</b>	<b>GND18090B</b>	<b>GBS18090B</b>
200 x 90	<b>1.880,00</b>	<b>GOA20090B</b>	<b>GOB20090B</b>	<b>GPA20090B</b>	<b>GND20090B</b>	<b>GBS20090B</b>



## PANNELLI DI RIVESTIMENTO / WALL COVERINGS



**Pannelli di rivestimento in abbinamento.**  
Wall panels combined with shower trays.

**Installazione / Installation:**  
Pannelli posizionabili in verticale e orizzontale.  
Placeable panels vertically and horizontally.

**Spessore / Thickness:**  
Ritagliabili su misura. Spessore: 6 mm.  
Can be cut to size. Thickness: 6 mm.



**Per i rivestimenti a parete precisare:**

- Lato corto P dimensione totale
- Lato lungo L dimensione totale meno lo spessore del pannello di 6 mm

**For the wall panels, please consider:**

- Short side P total dimension
- Long side L total dimension less the thickness of the panel of 6 mm





**PIETRA / STONE****COLORI / COLORS****DIMENSIONI / DIMENSIONS****PREZZO / PRICE****CODICE / CODE**

210x110 dim. max

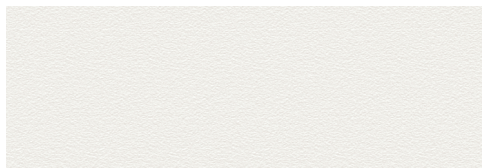
**331,00 al mq****S19434****S19495****S19493****S19512****S21038****S21042****VELLUTO / VELVET****COLORI / COLORS****DIMENSIONI / DIMENSIONS****PREZZO / PRICE****CODICE / CODE**

250x200 dim. max

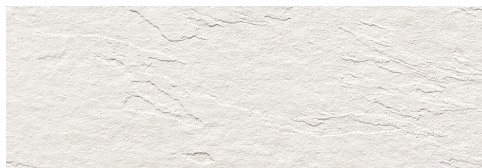
**331,00 al mq****S19437****S19498****S19496****S19497****S21039****S21043****ARDESIA / SLATE****COLORI / COLORS****DIMENSIONI / DIMENSIONS****PREZZO / PRICE****CODICE / CODE**

200x110 dim. max

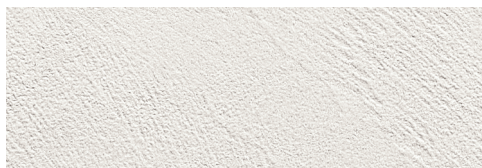
**331,00 al mq****S19435****S19521****S19519****S19524****S21040****S21044****CEMENTO / CEMENT****COLORI / COLORS****DIMENSIONI / DIMENSIONS****PREZZO / PRICE****CODICE / CODE**

250x200 dim. max

**331,00 al mq****S19525****S19528****S19526****S19529****S21041****S21045**

## RAMPA DI ACCESSO / ACCESS RAMP



**Rampa di accesso per piatto doccia, disponibile su richiesta nella collezione Easy Velluto.**

Access ramp for shower trays, available on request in the Easy Velvet collection.

**Dimensioni / Dimensions:**

Lunghezza 120 e 80 cm, altezza 2,5 cm, profondità 15 cm.  
Length 120 and 80 cm, height 2,5 cm, depth 15 cm.

**Finiture / Finishing:**

Disponibile nella finitura Velluto  
Available in Velvet finishing.

### VELLUTO / VELVET

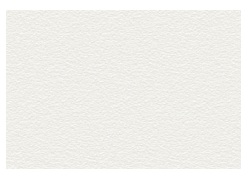

**COLORI / COLORS**



Bianco / White

Antracite / Anthracite

Grigio / Grey

Creta / Clay

Tortora / Dove

Cenere / Ash

**DIMENSIONI / DIMENSIONS**

**PREZZO / PRICE**

**CODICE / CODE**

L 80 cm

**103,00**

**RAMPA80**

L 120 cm

**155,00**

**RAMPA120**



## TAGLI REALIZZABILI / CUSTOM CUTS



Le dimensioni non indicate sul listino sono realizzabili eseguendo dei tagli. Si consiglia di tagliare max 10 cm per lato sulla lunghezza; per avere la piletta centrata effettuare due tagli max 5 cm per lato sulla profondità.

The sizes not specified in the price list can be obtained realising some cuts. It is suggested to cut maximum 10 cm each side on the length; in order to have the waste in the center, make two cuts of 5 cm maximum on each side on the depth.

### ATTENZIONE!

**I piatti doccia in gres porcellanato non sono ritagliabili, ma possono essere forniti su misura.**

Stoneware shower trays can not be cut, but they can be supplied in a custom size on demand.

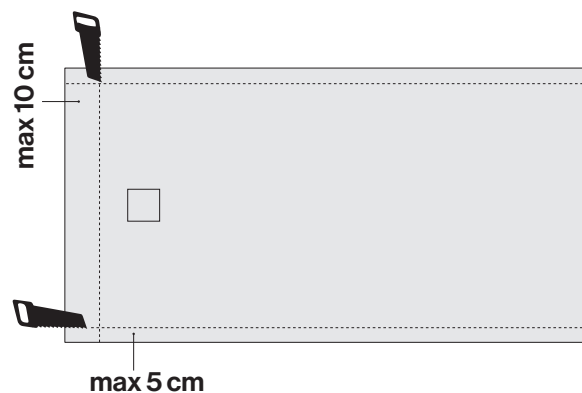

### PREZZO / PRICE

Piatti in Resina / Resin trays	<b>52,00 AL TAGLIO</b>
Piatti in Gres / Stoneware trays	<b>a richiesta / on demand</b>

**I piatti doccia in resina sono personalizzabili effettuando scansi, tagli e lavorazioni particolari con facilità.**

The resin shower trays can be customized by making shifts, cuts and special processes with ease.

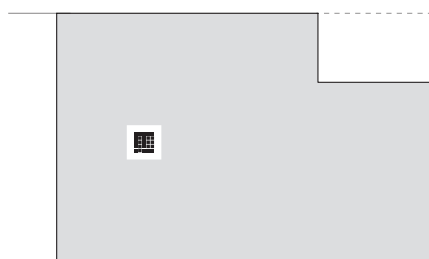

**Taglio scanso colonna**  
Cut for column

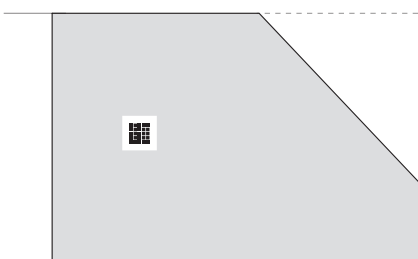

**Taglio muro diagonale**  
Cut for diagonal wall

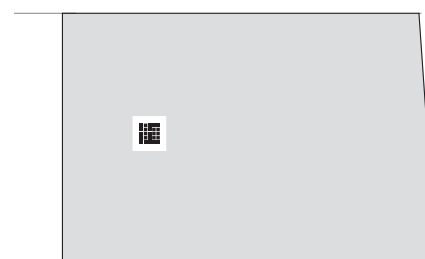

**Taglio fuori squadra**  
Cut out-of-square



## PILETTE / DRAINS



### Piletta standard orizzontale per foro Ø 90 mm.

Standard horizontal drain for Ø 90 mm hole.

Per i modelli / For models: **Basic, Cover, Outline, Easy, Mild, Soft, Light.**

DIMENSIONI / DIMENSIONS	CODICE / CODE	PREZZO / PRICE
H 54 mm	3164	23,00



### Piletta standard orizzontale.

Standard horizontal drain.

Per i modelli / For models: **Blind.**

	CODICE / CODE	PREZZO / PRICE
L 192 mm, P 47 mm, H 60 mm	3312	52,00

### OPZIONALE / OPTIONAL



### Piletta opzionale verticale per foro Ø 90 mm.

Optional vertical drain for Ø 90 mm hole.

Per i modelli / For models: **Basic, Cover, Outline, Easy, Mild, Soft, Light.**

	CODICE / CODE	PREZZO / PRICE
H 96 mm	3166	23,00

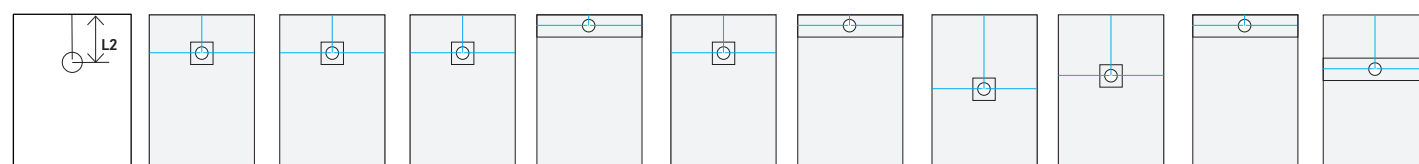
**POSIZIONE DEL FORO DI SCARICO / WASTE POSITION**

	<b>BASIC PIETRA</b>	<b>BASIC ARDESIA</b>	<b>BASIC CEMENTO</b>	<b>COVER</b>	<b>OUTLINE</b>	<b>BLIND</b>	<b>EASY</b>	<b>MILD</b>	<b>SOFT</b>	<b>LIGHT</b>
<b>L x P cm</b>	L2 (cm)	L2 (cm)	L2 (cm)	L2 (cm)	L2 (cm)	L2 (cm)	L2 (cm)	L2 (cm)	L2 (cm)	L2 (cm)
90 x 70	35	35	25	12		7	45			
100 x 70	30	41	25	12		7	50			
110 x 70	40	41	25	12		7				
120 x 70	40	41	25	12		7	60			
130 x 70	40	41	45	12		7				
140 x 70	40	41	45	12	40	7	70			
150 x 70	35	41	55							
160 x 70	40	41	55				80			
170 x 70	35	61	55							
180 x 70	40	61	55				90			
200 x 70	55	62	62				100			
80 x 80	40	40	40				40			
90 x 80	30	41	25	12		7	45			
100 x 80	30	41	25	12	30	7	50	40	12	40
110 x 80	40	41	25	12		7				
120 x 80	40	41	25	12	40	7	60	40	12	40
130 x 80	40	41	45	12		7				
140 x 80	40	41	45	12	40	7	70	40	12	40
150 x 80	35	41	55	12		7				
160 x 80	40	41	55	12		7	80	40	12	40
170 x 80	35	61	55	12		7				
180 x 80	40	61	55	12		7	90	40	12	40
200 x 80	55	62	62				100	40	12	40
90 x 90	35	45	45	12		7	45			
100 x 90	40	45	25	12		7	50			
110 x 90	40	45	25	12		7				
120 x 90	40	45	25	12		7	60	40	12	40
130 x 90	40	45	45	12		7				
140 x 90	40	45	45	12		7	70	40	12	40
150 x 90	50	45	55	12		7				
160 x 90	50	45	55	12		7	80	40	12	40
180 x 90	55	62	62				90	40	12	40
190 x 90	55	62	62							
200 x 90	55	62	62				100	40	12	40
100 x 100	40						50			
120 x 100	40									
140 x 100	40									
160 x 100	50									
180 x 100	55									
200 x 100	55									

## COPRIPILETTA / DRAIN COVERS

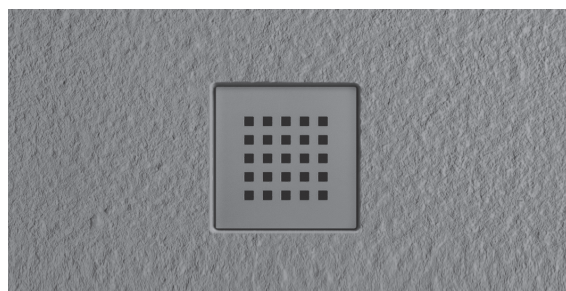

### GRIGLIA PER PIATTI / GRATE FOR SHOWER TRAYS: BASIC PIETRA, BASIC CEMENTO, OUTLINE

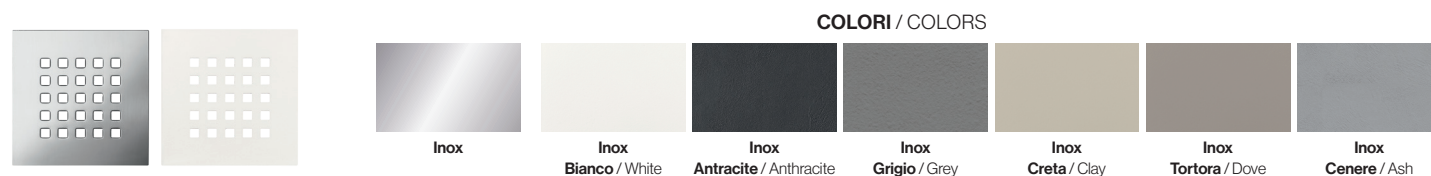

#### PREZZO / PRICE

#### CODICE / CODE

Un lato acciaio / One side steel <b>14,00 euro</b>	<b>1388</b>	-	-	-	-	-	-
Un lato verniciato / One side colored <b>26,00 euro</b>	-	<b>1405</b>	<b>2293</b>	<b>1969</b>	<b>3165</b>	<b>S21371</b>	<b>S21382</b>

### GRIGLIA PER PIATTI / GRATE FOR SHOWER TRAYS: BASIC ARDESIA



#### PREZZO / PRICE

#### CODICE / CODE

Un lato acciaio / One side steel <b>14,00 euro</b>	<b>2973</b>	-	-	-	-	-	-
Un lato verniciato / One side colored <b>26,00 euro</b>	-	<b>S19531</b>	<b>S19533</b>	<b>S19534</b>	<b>S19535</b>	<b>S20202</b>	<b>S21383</b>



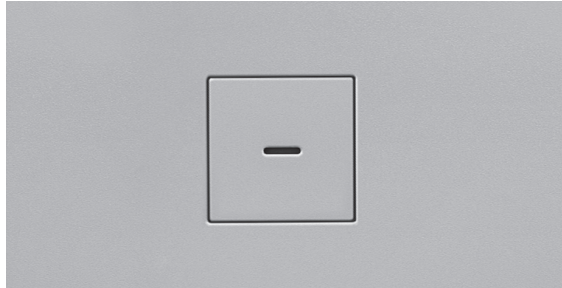

**COPRIPILETTA MATERICA PER PIATTI / MATERIAL DRAIN COVER FOR SHOWER TRAYS: EASY**

**COLORI / COLORS**

**PREZZO / PRICE**
**CODICE / CODE**

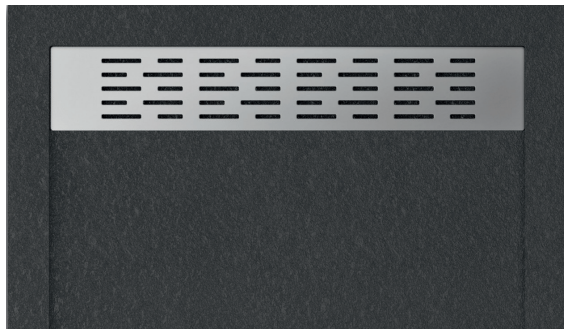
<b>52,00 euro</b>	<b>S19740</b>	<b>S20100</b>	<b>S20293</b>	<b>S20098</b>	<b>S21385</b>	<b>S21386</b>
-------------------	---------------	---------------	---------------	---------------	---------------	---------------

**GRIGLIA E COPRIPILETTA MATERICA PER PIATTI / MATERIAL DRAIN COVER FOR SHOWER TRAYS: COVER**

**COLORI / COLORS**

**PREZZO / PRICE**
**DIMENSIONI / DIMENSIONS**
**CODICE / CODE**

<b>Griglia / Grate</b> Un lato acciaio e un lato verniciato / One side steel and one side colored <b>65,00 euro</b>	L 70	<b>S20228</b>	<b>S21402</b>	<b>S21405</b>	<b>S21408</b>	<b>S21411</b>	<b>S21414</b>
	L 80	<b>S20229</b>	<b>S21403</b>	<b>S21406</b>	<b>S21409</b>	<b>S21412</b>	<b>S21415</b>
	L 90	<b>S20230</b>	<b>S21404</b>	<b>S21407</b>	<b>S21410</b>	<b>S21413</b>	<b>S21416</b>
<b>Copripilettina / Drain cover</b> <b>65,00 euro</b>	L 70	<b>S20284</b>	<b>S21387</b>	<b>S21390</b>	<b>S21393</b>	<b>S21396</b>	<b>S21399</b>
	L 80	<b>S20285</b>	<b>S21388</b>	<b>S21391</b>	<b>S21394</b>	<b>S21397</b>	<b>S21400</b>
	L 90	<b>S20286</b>	<b>S21389</b>	<b>S21392</b>	<b>S21395</b>	<b>S21398</b>	<b>S21401</b>

# INSTALLAZIONE / INSTALLATION

## POSIZIONAMENTO PIATTO DOCCIA E PILETTA SHOWER TRAY AND DRAIN POSITIONING

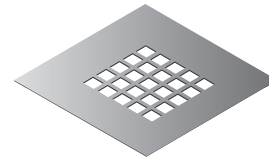
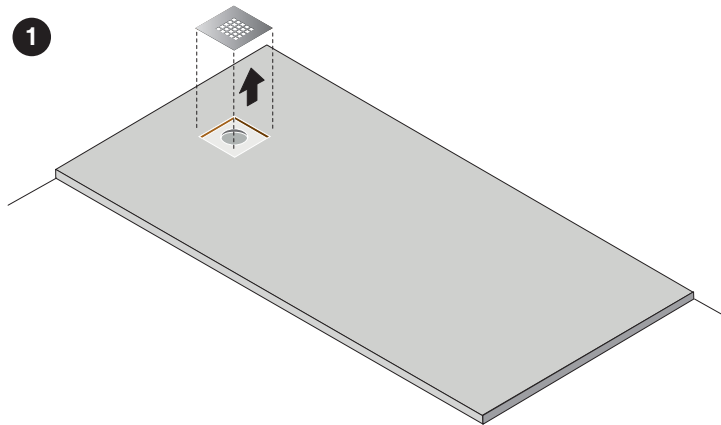

GRIGLIA / GRATE

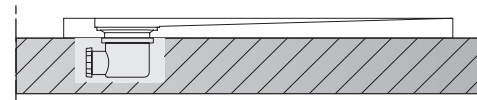
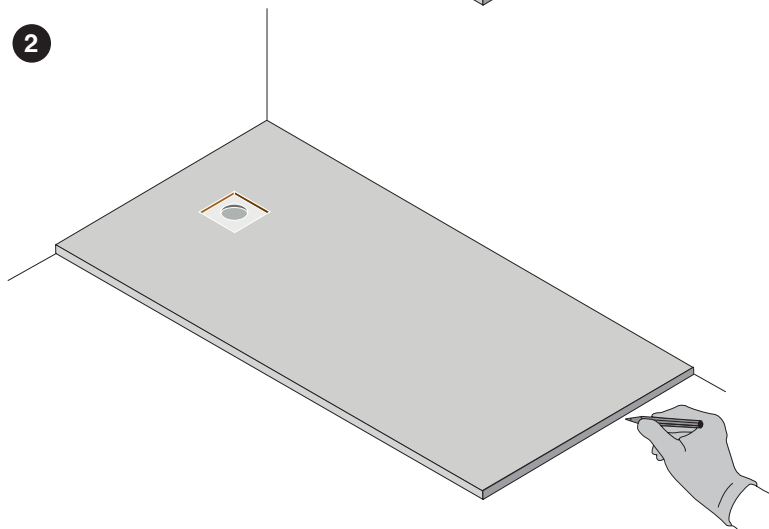

SPAZIO PER LA PILETTA / PLACE FOR THE DRAIN

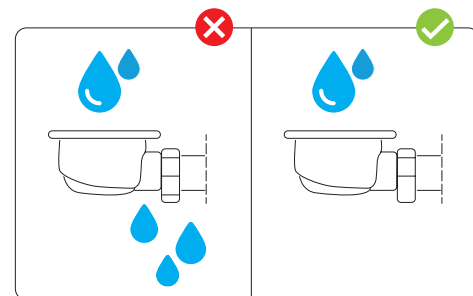
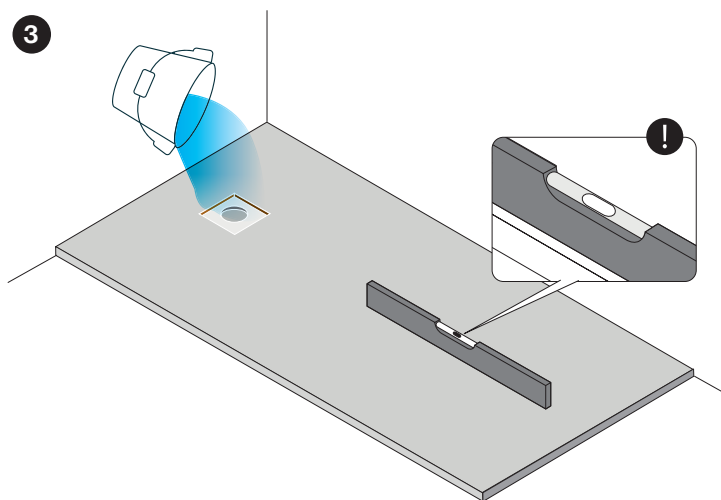

**FISSAGGIO E POSIZIONAMENTO PIATTO DOCCIA**  
FIXING AND POSIZIONING SHOWER TRAY

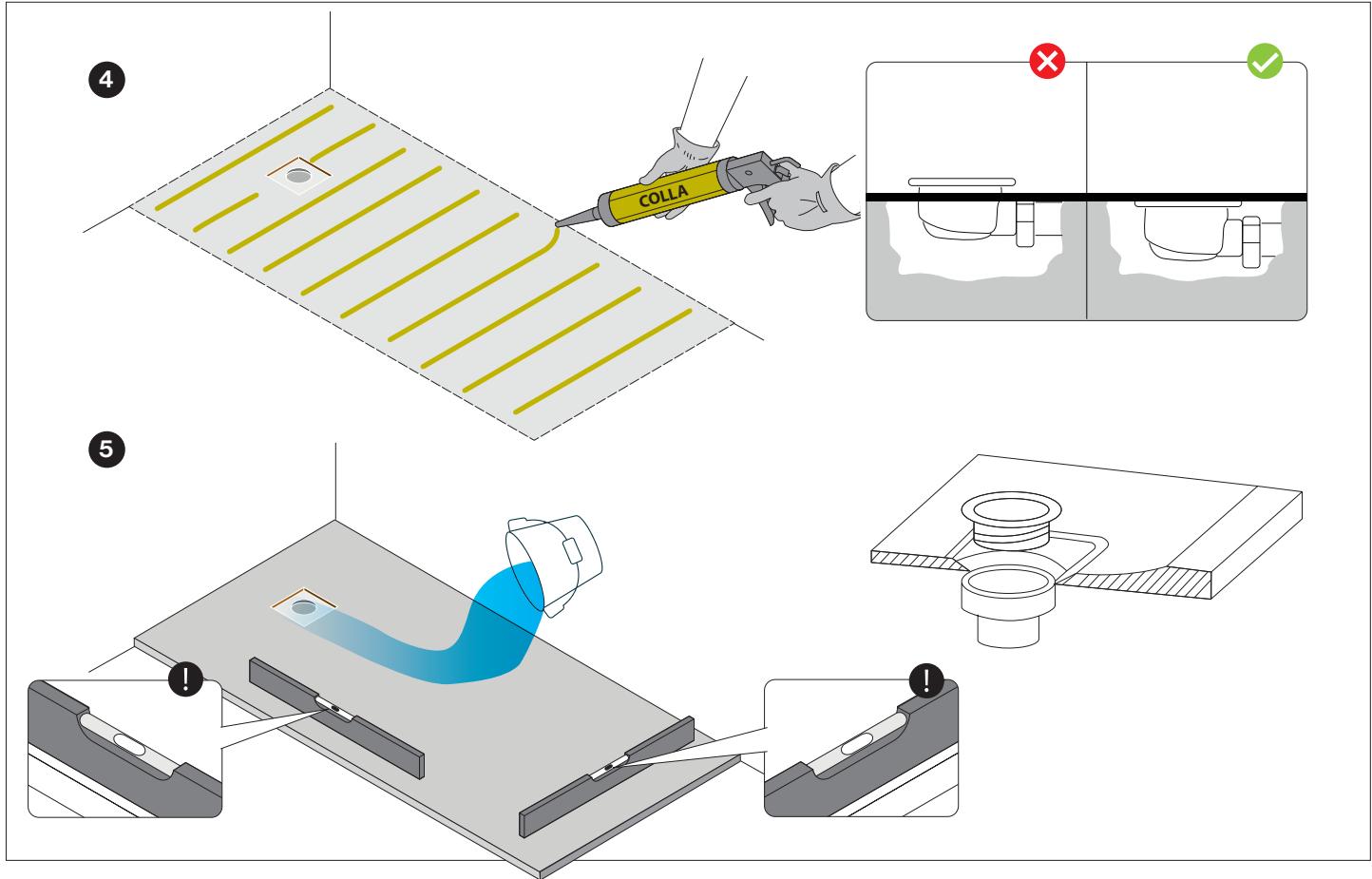

**IMPERMEABILIZZAZIONE**  
WATERPROOFING

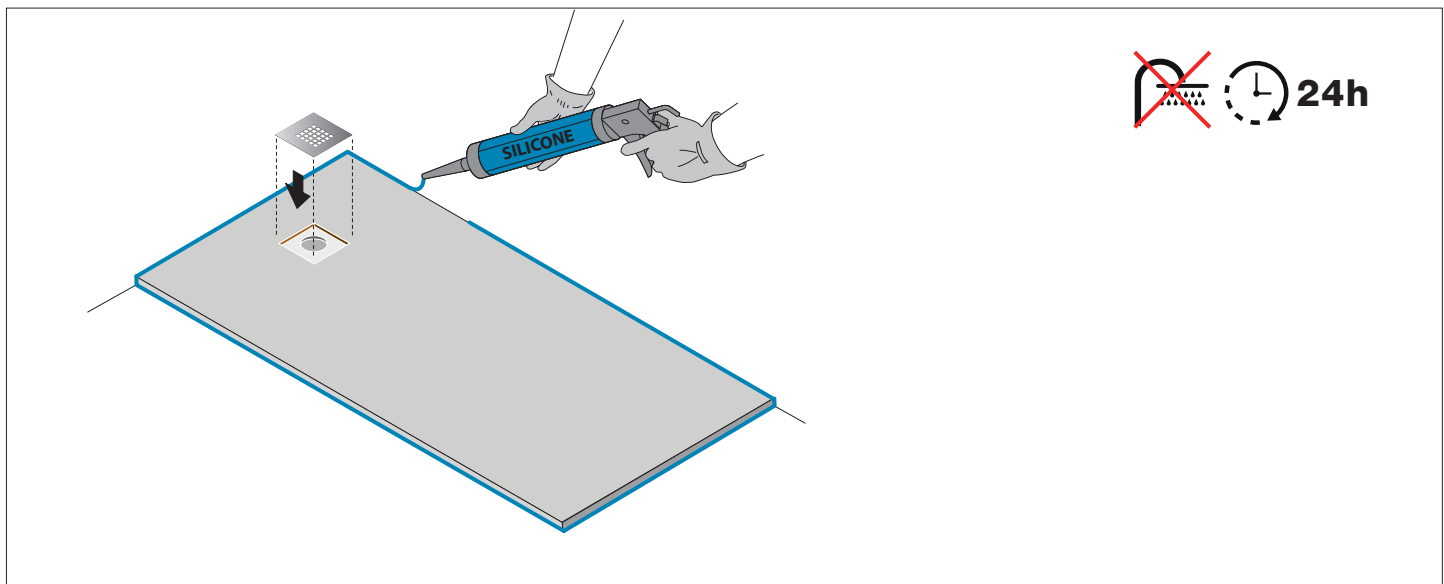



## CERTIFICAZIONI EUROPEE / EUROPEAN CERTIFICATIONS

### UNI EN 14527

**Pulibilità / Cleanability**

**Stabilità del fondo / Base stability**

**Evacuazione dell'acqua / Draining of water**

**Resistenza ai prodotti chimici e agenti macchianti / Resistance to chemicals and staining**

**Resistenza alle variazioni di temperatura / Resistance to temperature changes**

**Durabilità / Durability**

### UNE EN 251:2014

**Quote di raccordo / Connecting dimensions**

**Foro di scarico / Drain hole**

### DIN 51097

**Antiscivolo / Slip resistance**





## ISTRUZIONI PER LA MANUTENZIONE E PULIZIA DEL PRODOTTO

Le superfici dei nostri piatti mantengono un bellissimo aspetto per molti anni nelle normali condizioni di utilizzo, e richiedono solamente un minimo di cura.



### Raccomandazioni

Per la manutenzione ordinaria, risciacquare il piatto doccia con acqua e assicurare una ventilazione dell'ambiente. Per una pulizia più profonda, usare acqua e sapone o un prodotto neutro senza acidi o solventi. Non usare spugne abrasive.



### Kit riparazione piatti doccia per superfici graffiate o danneggiate

Utilizzare in caso di danneggiamento della superficie del piatto doccia.

#### Attrezzatura necessaria (non in dotazione)

- \_ Carta vetrata fine
- \_ Panno
- \_ Spatola
- \_ Nastro adesivo di carta
- \_ Rullo

1. Utilizzare il kit di riparazione dello stesso colore del piatto doccia: bianco, antracite, grigio, creta, tortora, cenere.
2. A seconda della profondità del danno, valutare se è sufficiente la verniciatura o se è necessaria la stuccatura.
3. Levigare la zona da stuccare utilizzando carta vetrata fine 220.
4. Pulire accuratamente la zona da riparare asportando la polvere; nel caso in cui tutto il piatto doccia sia da ripassare, pulirlo prima con acetone.
5. Mescolare il colore per renderlo omogeneo.
6. Unire il catalizzatore al 2% (2 gr di catalizzatore per ogni 100 gr di colore) e mescolare per circa un minuto.
7. Delimitare le zone da riparare con nastro adesivo.
8. Utilizzando il rullo prelevare una piccola quantità di composto e passarlo sulla zona da ritoccare; se si tratta di tutta la superficie del piatto, passare il rullo sempre nello stesso senso.
9. Rimuovere il nastro adesivo di carta.
10. Attendere 12/15 ore affinché il composto si essicchi completamente.

## CARE & CLEANING GUIDELINES

The surface of all our shower trays with normal use will retain its beauty with only a minimal amount of care.

### Recommendation

For ordinary maintenance, just rinse the tray with water and ventilate the bathroom. For thorough cleaning, use water and soap or a neutral cleaning product which contains no acid or solvent. Do not use abrasives sponges.

### Shower tray's repair kit for scratched or damaged surfaces

To use in case of damage of the shower tray surface.

#### Equipment needed (not included)

- \_ Thin sandpaper
- \_ Cloth
- \_ Spatula
- \_ Paper adhesive tape
- \_ Roll

1. Use the repair kit of the same colour then the shower tray: white, charcoal, platinum, clay, dove, ash.
2. Depending on the damage's depth, consider if the painting is enough or if it is necessary to plaster.
3. Smooth the zone to plaster with a 220 thin sandpaper.
4. Clean carefully the zone to repair, removing the dust. If the whole shower tray has to be repaired, clean it with acetone.
5. Mix the colour to make it uniform.
6. Add the catalyst at 2% (2 gram of catalyst for 100 gram of colour), then mix for about one minute.
7. Define the zone to repair with adhesive tape.
8. Using the roll, take a small quantity of the mixture and pass it on the area to repair; if the whole surface of the tray has to be repaired, pass the roll always in the same way.
9. Remove the paper adhesive tape.
10. Wait 12/15 hours since the mixture is totally dry.

## KIT RIPARAZIONE PIATTI DOCCIA / SHOWER TRAY'S REPAIR KIT

COLORI / COLORS	PREZZO / PRICE	CODICE / CODE
Bianco / White	52,00	S11979
Antracite / Anthracite	52,00	S18894
Grigio / Grey	52,00	S18302
Creta / Clay	52,00	S20294
Tortora / Dove	52,00	S19906
Cenere / Ash	52,00	S21370



## CONDIZIONI DI VENDITA

**VALIDITÀ** Gli ordini sono assunti sempre e comunque salvo approvazione della ditta. Il presente listino annulla e sostituisce tutti i precedenti.

**PREZZI E CONDIZIONI DI PAGAMENTO** I prezzi si intendono IVA esclusa, sono espressi in Euro e si intendono quali quotazioni al pubblico. Per i pagamenti frazionati con rate inferiori a Euro 250,00 le scadenze saranno sostituite con una rata unica avente scadenza media inferiore. Il ritardo di pagamento, anche di una sola rata autorizza la ditta fornitrice a chiedere l'integrale pagamento con l'addebito degli interessi di mora applicati al tasso ufficiale di sconto in vigore, maggiorato di 5 punti percentuali.

**DATI TECNICI** I dati tecnici del presente listino sono indicativi, si declina ogni responsabilità per eventuali inesattezze o errori in esso contenuto. Ci riserviamo inoltre la facoltà di apportare modifiche e/o migliorie ai nostri prodotti in qualsiasi momento, anche senza preavviso. Le misure sono espresse in cm.

**ELEMENTI SPECIALI FUORI SERIE/FUORI MISURA** Tutte le richieste di prodotti con misure e caratteristiche fuori della norma del presente listino, vengono accettate con riserva da parte del nostro ufficio tecnico, che sarà comunque sempre a disposizione nel vagliare attentamente le esigenze proposte dalla particolare situazione. In caso di accettazione, l'eventuale maggiorazione di prezzo sarà comunicata.

**SPEDIZIONE E TRASPORTO** Il trasporto verrà addebitato forfettariamente al 2%. Per ordini inferiori a 200 euro netto (350 euro netto per Calabria ed Isole) verrà addebitato un contributo spese per il trasporto di 20 euro netto (30 euro netto Calabria e Isole). Sarà cura dell'acquirente, all'atto del ricevimento della merce, controllare quantità ed eventuali danni da segnalarsi immediatamente con apposita riserva scritta sul documento di trasporto. La mancata osservanza di quanto sopra solleva RCR da ogni responsabilità e risarcimento.

**CONSEGNA** I termini di consegna forniti dalla ditta fornitrice hanno valore puramente indicativo e non vincolante. Il documento di consegna firmato al momento dello scarico è considerato una dichiarazione di corrispondenza di quanto in esso elencato e del suo perfetto stato.

**CONTESTAZIONI E RESI** Eventuali contestazioni sulla qualità e quantità della merce ricevuta dovranno essere notificate dal committente alla ditta, esclusivamente mediante e-mail o fax entro 8 giorni dall'avvenuta consegna. Non sono comunque ammessi resi di merce non preventivamente autorizzati per iscritto dalla ditta. La valutazione del reso verrà determinata presso la nostra sede dopo averne preso visione. Nessun risarcimento sarà riconosciuto al cliente, per errori imputabili alla casa fornitrice, salvo, la sostituzione degli elementi sbagliati o difettati. Non verrà accettata, in nessun caso, la restituzione di elementi speciali fuori serie. Anche nel caso di contestazione tempestiva i pagamenti non possono essere sospesi. Il ritardato pagamento anche di una sola rata dà diritto alla ditta di richiedere l'integrale pagamento con l'addebito degli interessi di mora a la immediata risoluzione dei contratti.

**INSTALLAZIONE DEL PRODOTTO** È importante che l'installazione venga eseguita da persone realmente competenti; si declina ogni responsabilità per errati montaggi.

**GARANZIA** Tutti i prodotti sono coperti da una garanzia di 5 anni. La garanzia si applica per eventuali difetti di produzione e non per danni derivanti da un'impropria installazione, uso e manutenzione.

**FORO COMPETENTE** Per qualsiasi controversia è competente il foro di Pordenone.

## CONDITIONS OF SALE

**VALIDITY** Orders are always accepted with the company approval. The present price list cancels and substitutes all the previous price lists.

**PRICES AND PAIEMENT CONDITIONS** The prices are considered excluding taxes, duties and VAT, are expressed in € (Euro) and are considered as retail prices. Paiements must be effected as agreed on the sales conditions contract or on the order confirmation.

**TECHNICAL DETAILS** The technical details on this price list are indicative, we don't assume any responsibility for any inaccuracies or mistakes included on the price list. We reserve the right to make changes or improvements to our products at any time without prior notice. Dimensions are expressed in cm.

**SPECIAL ELEMENTS OUT OF DIMENSION** All requests for products with dimensions and features outside the standard of this list will be accepted by our technical department, but will always be at your disposal in carefully examining the requirements of the particular situation. In case of acceptance, any price increase will be communicated.

**SHIPPING AND TRANSPORTATION** Transportation will be charged at a flat rate of 2%. For orders of less than 200 euros net (350 euros net for Calabria and the islands) a contribution will be charged for transport costs of 20 euros net (30 euros net for Calabria and the islands). It will be the responsibility of the buyer, upon receipt of the goods, to check the quantity and any damage to be reported immediately with a specific written reservation on the transport document. Failure to comply with the above releases RCR from any liability and compensation.

**DELIVERY** Delivery times provided by the company supplier are indicative and not binding. The delivery document signed at the time of discharge is considered a declaration of correspondence as listed in it and its perfect.

**DISPUTE** Any complaints on qualities or quantities of goods received must be notified by the company to the buyer exclusively by e-mail or fax within 8 days from delivery. Send back of damaged goods is not accepted except and can be done for goods previously authorized in writing by the company. Assessment made will be determined at the headquarters of the company after having controlled the origin of the damage. No compensation will be granted to any client for errors attributable to the supplying company, except the replacement of wrong or defective items. Will not be accepted under any circumstances, the return of special items out of dimension.

**INSTALLATION OF THE PRODUCTS** It is very important that the installation will be done by people actually competent; Company is not responsible for incorrect or inappropriate edits.

**WARRANTY** All products are covered by a 5 year warranty. The warranty applies to any manufacturing defects and not to damage resulting from improper installation, use and maintenance.

**JURISDICTION** For any dispute is responsible to the Court of Pordenone.

## Shower trays