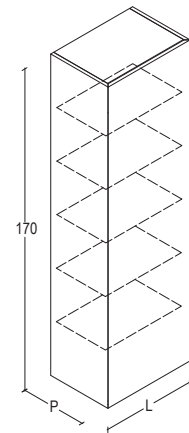
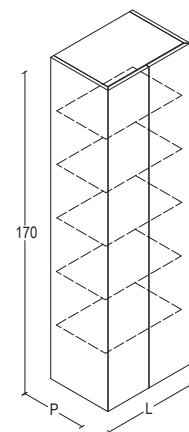

**AIRY EDGE | COLONNE H. 170 - SPECIFICARE IL SENSO DI APERTURA**

AIRY EDGE  
COLUMNS H. 170  
SPECIFY OPENING DIRECTION

**COLONNA 1 ANTA**  
COLUMN W/1 DOOR

 **ILLUMINAZIONE INTERNA DISPONIBILE**  
INTERNAL LIGHTING AVAILABLE

**COLONNA 2 ANTE**  
COLUMN W/2 DOORS

 **ILLUMINAZIONE INTERNA DISPONIBILE**  
INTERNAL LIGHTING AVAILABLE

DIMENSIONI DIMENSIONS	CODICE CODE	①	②	④ ⑤
P. 22	<b>56001101</b>	566,00	814,00	991,00
L. 25				
P. 35	<b>56001102</b>	665,00	988,00	1.232,00
L. 35				
P. 22	<b>56001104</b>	618,00	940,00	1.149,00
L. 35				
P. 35	<b>56001105</b>	734,00	1.133,00	1.414,00
L. 50				
P. 22	<b>56001107</b>	692,00	1.121,00	1.381,00
L. 50				
P. 35	<b>56001108</b>	828,00	1.343,00	1.677,00
L. 50				
P. 22	<b>56006051</b>	811,00	1.227,00	1.493,00
L. 50				
P. 35	<b>56006052</b>	949,00	1.449,00	1.785,00
L. 70				
P. 22	<b>56006054</b>	931,00	1.493,00	1.819,00
L. 70				
P. 35	<b>56006055</b>	1.107,00	1.758,00	2.162,00

**AIRY SISTEMA**  
AIRY SISTEMA

**AIRY SISTEMA**  
**BASI SOSPESA H. 25**  
*AIRY SISTEMA*  
*WALL HUNG BASES H. 25*

**AIRY SISTEMA | ACCESSORI PER BASI H. 25 - OPZIONALI**

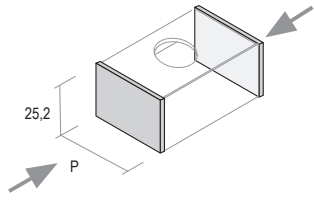
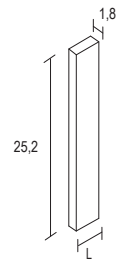





AIRY SISTEMA ACCESSORIES FOR BASES H. 25		DIMENSIONI DIMENSIONS	CODICE CODE	①	②	③	④	⑤	⑥	⑦
<b>FIANCO DI FINITURA SP. 1,2</b> ADDITIONAL FINISHING SIDE-PANEL TH. 1.2 	H. 25	P. 35	<b>19000001</b>	51,00	70,00	81,00				136,00
		P. 46	<b>19000002</b>	58,00	84,00	103,00				176,00
		P. 51	<b>19000003</b>	58,00	84,00	103,00				176,00
		P. 62	<b>19000022</b>	62,00	92,00	117,00				227,00
<b>FASCIA DI TAMPONAMENTO PER BASE H. 25</b> FILLER WOODEN-STRIP FOR BASES H.25 		H. 25	L. 5 - 15	<b>19126005</b>	36,00	53,00	58,00			94,00

**N.B. I PREZZI SI RIFERISCONO AD UN SINGOLO FIANCO**  
 N.B. THE PRICES REFER TO A SINGLE SIDE-PANEL

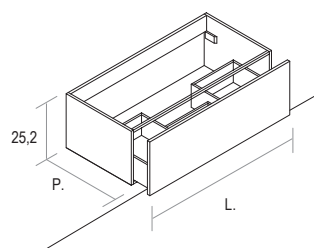
**N.B. MISURA MINIMA L. 5 CM E MASSIMA L. 15 CM**  
 N.B. MIN. L. 5 CM AND MAX L. 15 CM

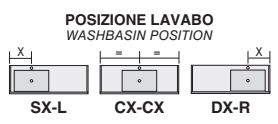
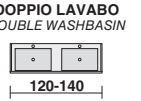
**FINITURE/FINISHES:**  
 ① NOBILITATO; ② LACCATO OPACO; ③ LACCATO LUCIDO; ④ LACCATO METALLO; ⑤ IMPIALLACCIATO; ⑥ HPL; ⑦ RESINA CEMENTO  
 ① MELAMINE; ② MATT LACQUERED; ③ GLOSSY LACQUERED; ④ METAL LACQUERED; ⑤ VENEREED WOOD; ⑥ HPL; ⑦ RESIN CEMENT

**AIRY SISTEMA | BASI SOSPESSE H. 25**

AIRY SISTEMA WALL HUNG BASES H.25		DIMENSIONI DIMENSIONS	CODICE CODE	①	②	③	④	⑤	⑥	⑦
<b>BASE LAVABO 1 CASSETTO</b> WASHBASIN BASE W/1 DRAWER 	L. 60	P. 35	<b>12108001</b>	424,00	472,00	534,00				697,00
		P. 46	<b>12108002</b>	461,00	521,00	598,00				805,00
		P. 51	<b>12108003</b>	461,00	521,00	598,00				805,00
		P. 62	<b>12108050</b>	484,00	553,00	639,00				874,00
 <b>ILLUMINAZIONE INTERNA DISPONIBILE</b> INTERNAL LIGHTING AVAILABLE	L. 70	P. 35	<b>12108004</b>	437,00	494,00	561,00				736,00
		P. 46	<b>12108005</b>	477,00	546,00	628,00				845,00
		P. 51	<b>12108006</b>	477,00	546,00	628,00				845,00
		P. 62	<b>12108051</b>	500,00	579,00	671,00				917,00
	L. 85	P. 35	<b>12108007</b>	484,00	553,00	627,00				819,00
		P. 46	<b>12108008</b>	528,00	610,00	698,00				934,00
		P. 51	<b>12108009</b>	528,00	610,00	698,00				934,00
		P. 62	<b>12108052</b>	554,00	644,00	743,00				1.009,00
	L. 95	P. 35	<b>12108053</b>	510,00	587,00	666,00				871,00
		P. 46	<b>12108054</b>	557,00	646,00	740,00				987,00
		P. 51	<b>12108055</b>	557,00	646,00	740,00				987,00
		P. 62	<b>12108056</b>	584,00	682,00	786,00				1.064,00
 <b>ILLUMINAZIONE INTERNA DISPONIBILE</b> INTERNAL LIGHTING AVAILABLE	L. 105	P. 35	<b>12108010</b>	528,00	611,00	696,00				912,00
		P. 46	<b>12108011</b>	578,00	674,00	773,00				1.032,00
		P. 51	<b>12108012</b>	578,00	674,00	773,00				1.032,00
		P. 62	<b>12108057</b>	608,00	710,00	819,00				1.109,00
 <b>ILLUMINAZIONE INTERNA DISPONIBILE</b> INTERNAL LIGHTING AVAILABLE	L. 120	P. 35	<b>12108013</b>	562,00	653,00	745,00				980,00
		P. 46	<b>12108014</b>	616,00	720,00	825,00				1.103,00
		P. 51	<b>12108015</b>	616,00	720,00	825,00				1.103,00
		P. 62	<b>12108058</b>	648,00	759,00	876,00				1.184,00
 <b>ILLUMINAZIONE INTERNA DISPONIBILE</b> INTERNAL LIGHTING AVAILABLE	L. 140	P. 35	<b>12108034</b>	601,00	713,00	814,00				1.073,00
		P. 46	<b>12108035</b>	661,00	785,00	901,00				1.202,00
		P. 51	<b>12108036</b>	661,00	785,00	901,00				1.202,00
		P. 62	<b>12108059</b>	696,00	827,00	954,00				1.287,00

**FINITURE/FINISHES:**  
 ① NOBILITATO; ② LACCATO OPACO; ③ LACCATO LUCIDO; ④ LACCATO METALLO; ⑤ IMPIALLACCIATO; ⑥ HPL; ⑦ RESINA CEMENTO  
 ① MELAMINE; ② MATT LACQUERED; ③ GLOSSY LACQUERED; ④ METAL LACQUERED; ⑤ VENEREED WOOD; ⑥ HPL; ⑦ RESIN CEMENT

## AIRY SISTEMA | BASI SOSPESSE H. 25

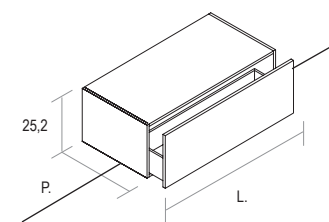
AIRY SISTEMA  
WALL HUNG BASES H.25BASE 1 CASSETTO  
BASE W/1 DRAWER
 ILLUMINAZIONE INTERNA  
DISPONIBILE  
INTERNAL LIGHTING AVAILABLE

DIMENSIONI DIMENSIONS	CODICE CODE	①	②	③	④	⑤	⑥	⑦
L. 50	P. 35	<b>12008001</b>	300,00	349,00	408,00			556,00
	P. 46	<b>12008002</b>	335,00	392,00	464,00			655,00
	P. 51	<b>12008003</b>	335,00	392,00	464,00			655,00
	P. 62	<b>12008050</b>	355,00	419,00	501,00			721,00
L. 60	P. 35	<b>12008004</b>	322,00	379,00	441,00			601,00
	P. 46	<b>12008005</b>	359,00	424,00	501,00			704,00
	P. 51	<b>12008006</b>	359,00	424,00	501,00			704,00
	P. 62	<b>12008051</b>	380,00	452,00	538,00			772,00
L. 70	P. 35	<b>12008007</b>	358,00	423,00	491,00			663,00
	P. 46	<b>12008008</b>	398,00	471,00	553,00			768,00
	P. 51	<b>12008009</b>	398,00	471,00	553,00			768,00
	P. 62	<b>12008052</b>	422,00	499,00	592,00			836,00
L. 85	P. 35	<b>12008010</b>	434,00	510,00	586,00			777,00
	P. 46	<b>12008011</b>	483,00	566,00	657,00			890,00
	P. 51	<b>12008012</b>	483,00	566,00	657,00			890,00
	P. 62	<b>12008053</b>	505,00	595,00	695,00			960,00
L. 95	P. 35	<b>12008054</b>	458,00	542,00	622,00			825,00
	P. 46	<b>12008055</b>	510,00	601,00	696,00			942,00
	P. 51	<b>12008056</b>	510,00	601,00	696,00			942,00
	P. 62	<b>12008057</b>	533,00	630,00	735,00			1.012,00
L. 105	P. 35	<b>12008013</b>	473,00	565,00	649,00			865,00
	P. 46	<b>12008014</b>	528,00	627,00	726,00			985,00
	P. 51	<b>12008015</b>	528,00	627,00	726,00			985,00
	P. 62	<b>12008058</b>	560,00	664,00	774,00			1.063,00
L. 120	P. 35	<b>12008016</b>	500,00	601,00	695,00			927,00
	P. 46	<b>12008017</b>	562,00	674,00	780,00			1.057,00
	P. 51	<b>12008018</b>	562,00	674,00	780,00			1.057,00
	P. 62	<b>12008059</b>	597,00	713,00	830,00			1.136,00
L. 140	P. 35	<b>12008046</b>	544,00	661,00	763,00			1.019,00
	P. 46	<b>12008047</b>	609,00	735,00	850,00			1.151,00
	P. 51	<b>12008048</b>	609,00	735,00	850,00			1.151,00
	P. 62	<b>12008060</b>	646,00	777,00	903,00			1.233,00

## FINITURE/FINISHES:

① NOBILITATO; ② LACCATO OPACO; ③ LACCATO LUCIDO; ④ LACCATO METALLO; ⑤ IMPIALLACCIATO; ⑥ HPL; ⑦ RESINA CEMENTO  
 ① MELAMINE; ② MATT LACQUERED; ③ GLOSSY LACQUERED; ④ METAL LACQUERED; ⑤ VENEREED WOOD; ⑥ HPL; ⑦ RESIN CEMENT

## AIRY SISTEMA | BASI SOSPESSE INFERIORI H. 25 DA PREVEDERE SOTTO BASE LAVABO

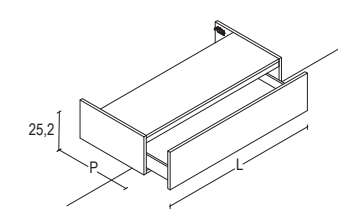
AIRY SISTEMA  
WALL HUNG LOWER BASES H.25  
TO BE USED UNDER WASHBASIN  
BASESBASE INFERIORE 1 CASSETTO  
LOWER-BASE W/1 DRAWER
 ILLUMINAZIONE INTERNA  
DISPONIBILE  
INTERNAL LIGHTING AVAILABLE

**! ATTENZIONE**  
**SUGGERITO L'UTILIZZO**  
**DEL SIFONE SALVASPAZIO**  
*ATTENTION*  
*USE OF THE SPACE-SAVING*  
*SIPHON IS RECOMMENDED*

DIMENSIONI DIMENSIONS	CODICE CODE	①	②	③	④	⑤	⑥	⑦
L. 60	P. 35	<b>13208001</b>	322,00	379,00	441,00			601,00
	P. 46	<b>13208002</b>	359,00	424,00	501,00			704,00
	P. 51	<b>13208003</b>	359,00	424,00	501,00			704,00
	P. 62	<b>13208004</b>	380,00	452,00	538,00			772,00
L. 70	P. 35	<b>13208005</b>	358,00	423,00	491,00			663,00
	P. 46	<b>13208006</b>	398,00	471,00	553,00			768,00
	P. 51	<b>13208007</b>	398,00	471,00	553,00			768,00
	P. 62	<b>13208008</b>	422,00	499,00	592,00			836,00
L. 85	P. 35	<b>13208009</b>	434,00	510,00	586,00			777,00
	P. 46	<b>13208010</b>	483,00	566,00	657,00			890,00
	P. 51	<b>13208011</b>	483,00	566,00	657,00			890,00
	P. 62	<b>13208012</b>	505,00	595,00	695,00			960,00
L. 95	P. 35	<b>13208013</b>	458,00	542,00	622,00			825,00
	P. 46	<b>13208014</b>	510,00	601,00	696,00			942,00
	P. 51	<b>13208015</b>	510,00	601,00	696,00			942,00
	P. 62	<b>13208016</b>	533,00	630,00	735,00			1.012,00
L. 105	P. 35	<b>13208017</b>	473,00	565,00	649,00			865,00
	P. 46	<b>13208018</b>	528,00	627,00	726,00			985,00
	P. 51	<b>13208019</b>	528,00	627,00	726,00			985,00
	P. 62	<b>13208020</b>	560,00	664,00	774,00			1.063,00
L. 120	P. 35	<b>13208021</b>	500,00	601,00	695,00			927,00
	P. 46	<b>13208022</b>	562,00	674,00	780,00			1.057,00
	P. 51	<b>13208023</b>	562,00	674,00	780,00			1.057,00
	P. 62	<b>13208024</b>	597,00	713,00	830,00			1.136,00
L. 140	P. 35	<b>13208025</b>	544,00	661,00	763,00			1.019,00
	P. 46	<b>13208026</b>	609,00	735,00	850,00			1.151,00
	P. 51	<b>13208027</b>	609,00	735,00	850,00			1.151,00
	P. 62	<b>13208028</b>	646,00	777,00	903,00			1.233,00

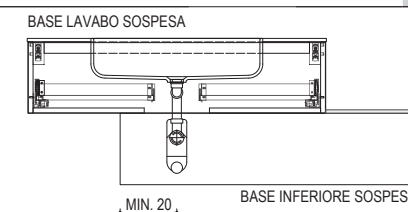
ESEMPIO  
EXAMPLE

## FINITURE/FINISHES:

① NOBILITATO; ② LACCATO OPACO; ③ LACCATO LUCIDO; ④ LACCATO METALLO; ⑤ IMPIALLACCIATO; ⑥ HPL; ⑦ RESINA CEMENTO  
 ① MELAMINE; ② MATT LACQUERED; ③ GLOSSY LACQUERED; ④ METAL LACQUERED; ⑤ VENEREED WOOD; ⑥ HPL; ⑦ RESIN CEMENT

**AIRY SISTEMA | BASI SOSPESSE INFERIORI H. 25 DA PREVEDERE SOTTO BASE LAVABO**

 AIRY SISTEMA  
 WALL HUNG LOWER BASES H. 25

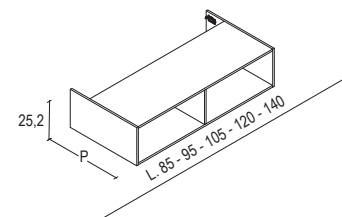
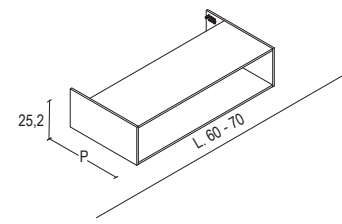
**BASE INFERIORE A GIORNO**  
 OPEN LOWER-BASE

**! ATTENZIONE**  
**SUGGERITO L'UTILIZZO**  
**DEL SIFONE SALVASPAZIO**  
*ATTENTION*  
*USE OF THE SPACE-SAVING*  
*SIPHON IS RECOMMENDED*

DIMENSIONI DIMENSIONS	CODICE CODE	①	②	③	④	⑤	⑥
L. 60	P. 35	<b>13317001</b>	205,00	354,00	424,00		
	P. 46	<b>13317002</b>	247,00	458,00	587,00		
	P. 51	<b>13317003</b>	247,00	458,00	587,00		
	P. 62	<b>13317004</b>	272,00	522,00	663,00		
L. 70	P. 35	<b>13317005</b>	238,00	430,00	471,00		
	P. 46	<b>13317006</b>	286,00	551,00	633,00		
	P. 51	<b>13317007</b>	286,00	551,00	633,00		
	P. 62	<b>13317008</b>	319,00	633,00	725,00		
L. 85	P. 35	<b>13317009</b>	261,00	477,00	522,00		
	P. 46	<b>13317010</b>	317,00	604,00	703,00		
	P. 51	<b>13317011</b>	317,00	604,00	703,00		
	P. 62	<b>13317012</b>	365,00	729,00	856,00		
L. 95	P. 35	<b>13317013</b>	278,00	507,00	555,00		
	P. 46	<b>13317014</b>	337,00	639,00	751,00		
	P. 51	<b>13317015</b>	337,00	639,00	751,00		
	P. 62	<b>13317016</b>	384,00	762,00	895,00		
L. 105	P. 35	<b>13317017</b>	312,00	567,00	621,00		
	P. 46	<b>13317018</b>	377,00	709,00	847,00		
	P. 51	<b>13317019</b>	377,00	709,00	847,00		
	P. 62	<b>13317020</b>	422,00	828,00	973,00		
L. 120	P. 35	<b>13317021</b>	335,00	614,00	672,00		
	P. 46	<b>13317022</b>	408,00	762,00	917,00		
	P. 51	<b>13317023</b>	408,00	762,00	917,00		
	P. 62	<b>13317024</b>	468,00	924,00	1.104,00		
L. 140	P. 35	<b>13317025</b>	369,00	674,00	738,00		
	P. 46	<b>13317026</b>	448,00	832,00	1.013,00		
	P. 51	<b>13317027</b>	448,00	832,00	1.013,00		
	P. 62	<b>13317028</b>	506,00	990,00	1.182,00		

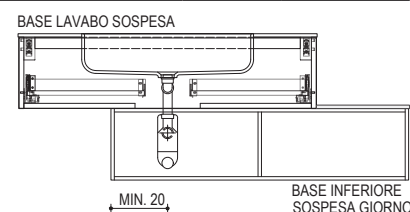
**ESEMPIO**  
 EXAMPLE

**FINITURE/FINISHES:**

 ① NOBILITATO; ② LACCATO OPACO; ③ LACCATO LUCIDO; ④ LACCATO METALLO; ⑤ IMPIALLACCIATO; ⑥ HPL  
 ① MELAMINE; ② MATT LACQUERED; ③ GLOSSY LACQUERED; ④ METAL LACQUERED; ⑤ VENEREED WOOD; ⑥ HPL

**AIRY SISTEMA | BASI SOSPESSE H. 25**

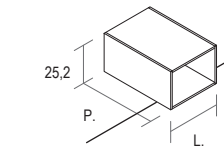
 AIRY SISTEMA  
 WALL HUNG BASES H.25

**BASE A GIORNO**  
 OPEN BASE

DIMENSIONI DIMENSIONS	CODICE CODE	①	②	③	④	⑤	⑥
L. 25	P. 35	<b>13017001</b>	151,00	250,00	280,00		
	P. 46	<b>13017002</b>	180,00	322,00	359,00		
	P. 51	<b>13017003</b>	180,00	322,00	359,00		
	P. 62	<b>13017004</b>	188,00	351,00	448,00		
L. 35	P. 35	<b>13017005</b>	165,00	277,00	340,00		
	P. 46	<b>13017006</b>	196,00	370,00	469,00		
	P. 51	<b>13017007</b>	196,00	370,00	469,00		
	P. 62	<b>13017008</b>	207,00	393,00	493,00		
L. 50	P. 35	<b>13017009</b>	188,00	324,00	391,00		
	P. 46	<b>13017010</b>	227,00	423,00	539,00		
	P. 51	<b>13017011</b>	227,00	423,00	539,00		
	P. 62	<b>13017012</b>	253,00	489,00	624,00		
L. 60	P. 35	<b>13017013</b>	205,00	354,00	424,00		
	P. 46	<b>13017014</b>	247,00	458,00	587,00		
	P. 51	<b>13017015</b>	247,00	458,00	587,00		
	P. 62	<b>13017016</b>	272,00	522,00	663,00		
L. 70	P. 35	<b>13017017</b>	238,00	430,00	471,00		
	P. 46	<b>13017018</b>	286,00	551,00	633,00		
	P. 51	<b>13017019</b>	286,00	551,00	633,00		
	P. 62	<b>13017020</b>	319,00	633,00	725,00		
L. 25	P. 35 - 46	<b>13417001</b>	234,00	387,00	431,00		
	P. 35 - 51	<b>13417002</b>	234,00	387,00	431,00		
L. 35	P. 35 - 46	<b>13417003</b>	255,00	444,00	563,00		
	P. 35 - 51	<b>13417004</b>	255,00	444,00	563,00		
L. 50	P. 35 - 46	<b>13417005</b>	296,00	508,00	647,00		
	P. 35 - 51	<b>13417006</b>	296,00	508,00	647,00		

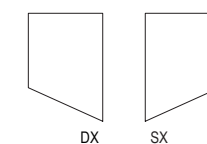
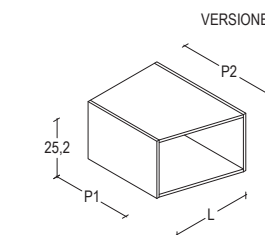
**BASE A GIORNO PER CAMBIO**  
**DI PROFONDITÀ DX-SX**  
 DEPTH-CHANGING OPEN BASE

**FINITURE/FINISHES:**

 ① NOBILITATO; ② LACCATO OPACO; ③ LACCATO LUCIDO; ④ LACCATO METALLO; ⑤ IMPIALLACCIATO; ⑥ HPL  
 ① MELAMINE; ② MATT LACQUERED; ③ GLOSSY LACQUERED; ④ METAL LACQUERED; ⑤ VENEREED WOOD; ⑥ HPL

**AIRY SISTEMA**  
**BASI SOSPESSE H. 35**

*AIRY SISTEMA*

*WALL HUNG BASES H. 35*

**AIRY SISTEMA | ACCESSORI PER BASI H. 35 - OPZIONALI**

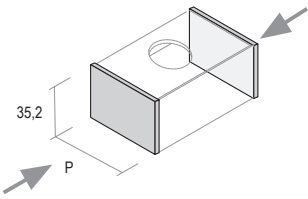
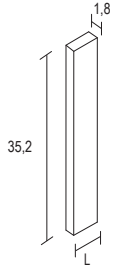
AIRY SISTEMA ACCESSORIES FOR BASES H. 35		DIMENSIONI DIMENSIONS	CODICE CODE	①	②	③ ④ ⑤ ⑥	⑦
<b>FIANCO DI FINITURA SP. 1,2</b> ADDITIONAL FINISHING SIDE-PANEL TH. 1.2 	P. 35	H. 35	<b>19000004</b>	63,00	90,00	103,00	189,00
	P. 46		<b>19000005</b>	75,00	109,00	131,00	244,00
	P. 51		<b>19000006</b>	75,00	109,00	131,00	244,00
	P. 62		<b>19000023</b>	79,00	118,00	150,00	315,00
<b>FASCIA DI TAMPONAMENTO PER BASE H. 35</b> FILLER WOODEN-STRIP FOR BASES H.35 		H. 35 L. 5 - 15	<b>19126006</b>	50,00	74,00	81,00	131,00
<b>N.B. I PREZZI SI RIFERISCONO AD UN SINGOLO FIANCO</b> N.B.: THE PRICES REFER TO A SINGLE SIDE-PANEL  <b>N.B. MISURA MINIMA L. 5 CM E MASSIMA L. 15 CM</b> N.B. MIN. L. 5 CM AND MAX L. 15 CM							

**FINITURE/FINISHES:**  
 ① NOBILITATO; ② LACCATO OPACO; ③ LACCATO LUCIDO; ④ LACCATO METALLO; ⑤ IMPIALLACCIATO; ⑥ HPL; ⑦ RESINA CEMENTO  
 ① MELAMINE; ② MATT LACQUERED; ③ GLOSSY LACQUERED; ④ METAL LACQUERED; ⑤ VENEREED WOOD; ⑥ HPL; ⑦ RESIN CEMENT

**AIRY SISTEMA | BASI SOSPESSE H. 35**

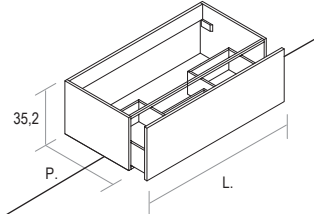
AIRY SISTEMA WALL HUNG BASES H. 35		DIMENSIONI DIMENSIONS	CODICE CODE	①	②	③ ④ ⑤ ⑥	⑦
<b>BASE LAVABO 1 CASSETTO</b> WASHBASIN BASE W/1 DRAWER 	L. 60	P. 35	<b>12108016</b>	424,00	472,00	534,00	697,00
		P. 46	<b>12108017</b>	461,00	521,00	598,00	805,00
		P. 51	<b>12108018</b>	461,00	521,00	598,00	805,00
		P. 62	<b>12108060</b>	484,00	553,00	639,00	874,00
	L. 70	P. 35	<b>12108019</b>	437,00	494,00	561,00	736,00
		P. 46	<b>12108020</b>	477,00	546,00	628,00	845,00
		P. 51	<b>12108021</b>	477,00	546,00	628,00	845,00
		P. 62	<b>12108061</b>	500,00	579,00	671,00	917,00
	L. 85	P. 35	<b>12108022</b>	484,00	553,00	627,00	819,00
		P. 46	<b>12108023</b>	528,00	610,00	698,00	934,00
		P. 51	<b>12108024</b>	528,00	610,00	698,00	934,00
		P. 62	<b>12108062</b>	554,00	644,00	743,00	1.009,00
L. 95	P. 35	<b>12108063</b>	510,00	587,00	666,00	871,00	
	P. 46	<b>12108064</b>	557,00	646,00	740,00	987,00	
	P. 51	<b>12108065</b>	557,00	646,00	740,00	987,00	
	P. 62	<b>12108066</b>	584,00	682,00	786,00	1.064,00	
L. 105	P. 35	<b>12108025</b>	528,00	611,00	696,00	912,00	
	P. 46	<b>12108026</b>	578,00	674,00	773,00	1.032,00	
	P. 51	<b>12108027</b>	578,00	674,00	773,00	1.032,00	
	P. 62	<b>12108067</b>	608,00	710,00	819,00	1.109,00	
L. 120	P. 35	<b>12108028</b>	562,00	653,00	745,00	980,00	
	P. 46	<b>12108029</b>	616,00	720,00	825,00	1.103,00	
	P. 51	<b>12108030</b>	616,00	720,00	825,00	1.103,00	
	P. 62	<b>12108068</b>	648,00	759,00	876,00	1.184,00	
L. 140	P. 35	<b>12108031</b>	601,00	713,00	814,00	1.073,00	
	P. 46	<b>12108032</b>	661,00	785,00	901,00	1.202,00	
	P. 51	<b>12108033</b>	661,00	785,00	901,00	1.202,00	
	P. 62	<b>12108069</b>	696,00	827,00	954,00	1.287,00	

**FINITURE/FINISHES:**  
 ① NOBILITATO; ② LACCATO OPACO; ③ LACCATO LUCIDO; ④ LACCATO METALLO; ⑤ IMPIALLACCIATO; ⑥ HPL; ⑦ RESINA CEMENTO  
 ① MELAMINE; ② MATT LACQUERED; ③ GLOSSY LACQUERED; ④ METAL LACQUERED; ⑤ VENEREED WOOD; ⑥ HPL; ⑦ RESIN CEMENT

**AIRY SISTEMA | BASI SOSPESA H. 35**

AIRY SISTEMA WALL HUNG BASES H. 35		DIMENSIONI DIMENSIONS	CODICE CODE	①	②	③ ④ ⑤ ⑥	⑦
<b>BASE LAVABO 1 CASSETTO + CASSETTO INTERNO H. 10</b> WASHBASIN BASE W/1 DRAWER + 1 INTERNAL DRAWER H. 10	L. 60	P. 35	<b>12125005</b>	551,00	608,00	671,00	838,00
		P. 46	<b>12125006</b>	597,00	661,00	740,00	949,00
		P. 51	<b>12125007</b>	597,00	661,00	740,00	949,00
		P. 62	<b>12125008</b>	622,00	693,00	780,00	1.021,00
	L. 70	P. 35	<b>12125009</b>	576,00	641,00	709,00	887,00
		P. 46	<b>12125010</b>	626,00	698,00	781,00	1.003,00
		P. 51	<b>12125011</b>	626,00	698,00	781,00	1.003,00
		P. 62	<b>12125012</b>	653,00	730,00	823,00	1.075,00
	L. 85	P. 35	<b>12125013</b>	639,00	714,00	790,00	987,00
		P. 46	<b>12125014</b>	695,00	779,00	868,00	1.109,00
		P. 51	<b>12125015</b>	695,00	779,00	868,00	1.109,00
		P. 62	<b>12125016</b>	768,00	857,00	958,00	1.231,00
L. 95	P. 35	<b>12125017</b>	676,00	758,00	839,00	1.049,00	
	P. 46	<b>12125018</b>	736,00	827,00	921,00	1.174,00	
	P. 51	<b>12125019</b>	736,00	827,00	921,00	1.174,00	
	P. 62	<b>12125020</b>	810,00	907,00	1.012,00	1.297,00	
L. 105	P. 35	<b>12125021</b>	748,00	839,00	923,00	1.149,00	
	P. 46	<b>12125022</b>	812,00	911,00	1.010,00	1.278,00	
	P. 51	<b>12125023</b>	812,00	911,00	1.010,00	1.278,00	
	P. 62	<b>12125024</b>	832,00	937,00	1.045,00	1.342,00	
L. 120	P. 35	<b>12125025</b>	750,00	851,00	944,00	1.185,00	
	P. 46	<b>12125026</b>	818,00	930,00	1.036,00	1.320,00	
	P. 51	<b>12125027</b>	818,00	930,00	1.036,00	1.320,00	
	P. 62	<b>12125028</b>	852,00	969,00	1.086,00	1.400,00	
L. 140	P. 35	<b>12125029</b>	814,00	933,00	1.035,00	1.300,00	
	P. 46	<b>12125030</b>	892,00	1.018,00	1.134,00	1.444,00	
	P. 51	<b>12125031</b>	892,00	1.018,00	1.134,00	1.444,00	
	P. 62	<b>12125032</b>	930,00	1.060,00	1.187,00	1.526,00	

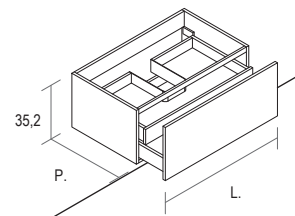

**ILLUMINAZIONE INTERNA  
DISPONIBILE**  
INTERNAL LIGHTING AVAILABLE

**! ATTENZIONE  
DISPONIBILE SOLO PER LAVABO  
IN APPOGGIO O VASCHE  
INTEGRATE SU TOP SCATOLATI A  
PARTIRE DALLO SP.8 CM**  
!ATTENTION  
ONLY AVAILABLE FOR SIT-ON BASIN OR  
BUILT-IN WASHBASIN FOR 8 CM TH (OR  
HIGHER) TOPS



**AIRY SISTEMA | BASI SOSPESA H. 35**

AIRY SISTEMA WALL HUNG BASES H. 35		DIMENSIONI DIMENSIONS	CODICE CODE	①	②	③ ④ ⑤ ⑥	⑦
<b>BASE 1 CASSETTO</b> BASE W/1 DRAWER	L. 25	P. 35	<b>12008019</b>	258,00	287,00	333,00	452,00
		P. 46	<b>12008020</b>	287,00	327,00	387,00	548,00
		P. 51	<b>12008021</b>	287,00	327,00	387,00	548,00
		P. 62	<b>12008065</b>	305,00	349,00	420,00	611,00
	L. 35	P. 35	<b>12008022</b>	275,00	311,00	363,00	494,00
		P. 46	<b>12008023</b>	304,00	351,00	417,00	588,00
		P. 51	<b>12008024</b>	304,00	351,00	417,00	588,00
		P. 62	<b>12008066</b>	321,00	371,00	446,00	649,00
	L. 50	P. 35	<b>12008025</b>	300,00	349,00	408,00	556,00
		P. 46	<b>12008026</b>	335,00	392,00	464,00	655,00
		P. 51	<b>12008027</b>	335,00	392,00	464,00	655,00
		P. 62	<b>12008067</b>	355,00	419,00	501,00	721,00
L. 60	P. 35	<b>12008028</b>	322,00	379,00	441,00	601,00	
	P. 46	<b>12008029</b>	359,00	424,00	501,00	704,00	
	P. 51	<b>12008030</b>	359,00	424,00	501,00	704,00	
	P. 62	<b>12008068</b>	380,00	452,00	538,00	772,00	
L. 70	P. 35	<b>12008031</b>	358,00	423,00	491,00	663,00	
	P. 46	<b>12008032</b>	398,00	471,00	553,00	768,00	
	P. 51	<b>12008033</b>	398,00	471,00	553,00	768,00	
	P. 62	<b>12008069</b>	422,00	499,00	592,00	836,00	
L. 85	P. 35	<b>12008034</b>	434,00	510,00	586,00	777,00	
	P. 46	<b>12008035</b>	483,00	566,00	657,00	890,00	
	P. 51	<b>12008036</b>	483,00	566,00	657,00	890,00	
	P. 62	<b>12008070</b>	505,00	595,00	695,00	960,00	
L. 95	P. 35	<b>12008071</b>	458,00	542,00	622,00	825,00	
	P. 46	<b>12008072</b>	510,00	601,00	696,00	942,00	
	P. 51	<b>12008073</b>	510,00	601,00	696,00	942,00	
	P. 62	<b>12008074</b>	533,00	630,00	735,00	1.012,00	
L. 105	P. 35	<b>12008037</b>	473,00	565,00	649,00	865,00	
	P. 46	<b>12008038</b>	528,00	627,00	726,00	985,00	
	P. 51	<b>12008039</b>	528,00	627,00	726,00	985,00	
	P. 62	<b>12008075</b>	560,00	664,00	774,00	1.063,00	
L. 120	P. 35	<b>12008040</b>	500,00	601,00	695,00	927,00	
	P. 46	<b>12008041</b>	562,00	674,00	780,00	1.057,00	
	P. 51	<b>12008042</b>	562,00	674,00	780,00	1.057,00	
	P. 62	<b>12008076</b>	597,00	713,00	830,00	1.136,00	
L. 140	P. 35	<b>12008043</b>	544,00	661,00	763,00	1.019,00	
	P. 46	<b>12008044</b>	609,00	735,00	850,00	1.151,00	
	P. 51	<b>12008045</b>	609,00	735,00	850,00	1.151,00	
	P. 62	<b>12008077</b>	646,00	777,00	903,00	1.233,00	

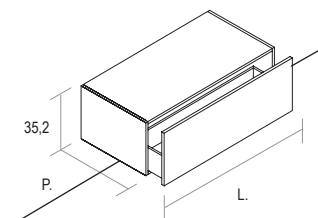

**ILLUMINAZIONE INTERNA  
DISPONIBILE**  
INTERNAL LIGHTING AVAILABLE



**AIRY SISTEMA | BASI SOSPESSE H. 35**

AIRY SISTEMA WALL HUNG BASES H. 35		DIMENSIONI DIMENSIONS	CODICE CODE	①	②	③ ④ ⑤ ⑥	⑦
<b>BASE 1 CASSETTO + CASSETTO INTERNO H. 10</b> BASE W/1 DRAWER + 1 INTERNAL DRAWER H. 10	L. 25	P. 35	<b>12025006</b>	355,00	386,00	433,00	554,00
		P. 46	<b>12025007</b>	386,00	424,00	485,00	648,00
		P. 51	<b>12025008</b>	386,00	424,00	485,00	648,00
		P. 62	<b>12025009</b>	402,00	446,00	517,00	712,00
L. 35	P. 35	<b>12025010</b>	385,00	423,00	473,00	608,00	
	P. 46	<b>12025011</b>	418,00	463,00	528,00	706,00	
	P. 51	<b>12025012</b>	418,00	463,00	528,00	706,00	
	P. 62	<b>12025013</b>	433,00	485,00	560,00	767,00	
L. 50	P. 35	<b>12025014</b>	426,00	475,00	533,00	686,00	
	P. 46	<b>12025015</b>	464,00	523,00	594,00	789,00	
	P. 51	<b>12025016</b>	464,00	523,00	594,00	789,00	
	P. 62	<b>12025017</b>	485,00	549,00	631,00	855,00	
L. 60	P. 35	<b>12025018</b>	458,00	516,00	578,00	742,00	
	P. 46	<b>12025019</b>	500,00	565,00	643,00	849,00	
	P. 51	<b>12025020</b>	500,00	565,00	643,00	849,00	
	P. 62	<b>12025021</b>	522,00	593,00	680,00	916,00	
L. 70	P. 35	<b>12025022</b>	504,00	568,00	637,00	814,00	
	P. 46	<b>12025023</b>	551,00	624,00	706,00	926,00	
	P. 51	<b>12025024</b>	551,00	624,00	706,00	926,00	
	P. 62	<b>12025025</b>	573,00	652,00	743,00	994,00	
L. 85	P. 35	<b>12025026</b>	597,00	672,00	748,00	944,00	
	P. 46	<b>12025027</b>	653,00	737,00	825,00	1.067,00	
	P. 51	<b>12025028</b>	653,00	737,00	825,00	1.067,00	
	P. 62	<b>12025029</b>	697,00	786,00	887,00	1.157,00	
L. 95	P. 35	<b>12025030</b>	631,00	715,00	795,00	1.004,00	
	P. 46	<b>12025031</b>	691,00	783,00	877,00	1.130,00	
	P. 51	<b>12025032</b>	691,00	783,00	877,00	1.130,00	
	P. 62	<b>12025033</b>	714,00	812,00	916,00	1.199,00	
L. 105	P. 35	<b>12025034</b>	657,00	748,00	833,00	1.054,00	
	P. 46	<b>12025035</b>	720,00	819,00	918,00	1.184,00	
	P. 51	<b>12025036</b>	720,00	819,00	918,00	1.184,00	
	P. 62	<b>12025037</b>	752,00	856,00	966,00	1.261,00	
L. 120	P. 35	<b>12025038</b>	683,00	785,00	878,00	1.117,00	
	P. 46	<b>12025039</b>	756,00	866,00	972,00	1.255,00	
	P. 51	<b>12025040</b>	756,00	866,00	972,00	1.255,00	
	P. 62	<b>12025041</b>	807,00	922,00	1.038,00	1.353,00	
L. 140	P. 35	<b>12025042</b>	763,00	882,00	983,00	1.248,00	
	P. 46	<b>12025043</b>	840,00	966,00	1.083,00	1.390,00	
	P. 51	<b>12025044</b>	840,00	966,00	1.083,00	1.390,00	
	P. 62	<b>12025045</b>	877,00	1.009,00	1.135,00	1.474,00	

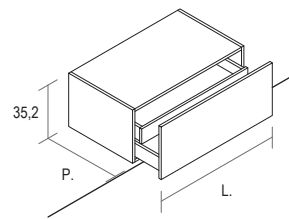

**ILLUMINAZIONE INTERNA DISPONIBILE**  
INTERNAL LIGHTING AVAILABLE

**AIRY SISTEMA | BASI SOSPESSE INFERIORI H. 35 DA PREVEDERE SOTTO BASE LAVABO**

AIRY SISTEMA WALL HUNG LOWER-BASES H. 35 TO BE USED UNDER WASHBASIN BASES		DIMENSIONI DIMENSIONS	CODICE CODE	①	②	③ ④ ⑤ ⑥	⑦
<b>BASE INFERIORE 1 CASSETTO</b> BASE W/1 DRAWER	L. 60	P. 35	<b>13208050</b>	322,00	379,00	441,00	601,00
		P. 46	<b>13208051</b>	359,00	424,00	501,00	704,00
		P. 51	<b>13208052</b>	359,00	424,00	501,00	704,00
		P. 62	<b>13208053</b>	380,00	452,00	538,00	772,00
L. 70	P. 35	<b>13208054</b>	358,00	423,00	491,00	663,00	
	P. 46	<b>13208055</b>	398,00	471,00	553,00	768,00	
	P. 51	<b>13208056</b>	398,00	471,00	553,00	768,00	
	P. 62	<b>13208057</b>	422,00	499,00	592,00	836,00	
L. 85	P. 35	<b>13208058</b>	434,00	510,00	586,00	777,00	
	P. 46	<b>13208059</b>	483,00	566,00	657,00	890,00	
	P. 51	<b>13208060</b>	483,00	566,00	657,00	890,00	
	P. 62	<b>13208061</b>	505,00	595,00	695,00	960,00	
L. 95	P. 35	<b>13208062</b>	458,00	542,00	622,00	825,00	
	P. 46	<b>13208063</b>	510,00	601,00	696,00	942,00	
	P. 51	<b>13208064</b>	510,00	601,00	696,00	942,00	
	P. 62	<b>13208065</b>	533,00	630,00	735,00	1.012,00	
L. 105	P. 35	<b>13208066</b>	473,00	565,00	649,00	865,00	
	P. 46	<b>13208067</b>	528,00	627,00	726,00	985,00	
	P. 51	<b>13208068</b>	528,00	627,00	726,00	985,00	
	P. 62	<b>13208069</b>	560,00	664,00	774,00	1.063,00	
L. 120	P. 35	<b>13208070</b>	500,00	601,00	695,00	927,00	
	P. 46	<b>13208071</b>	562,00	674,00	780,00	1.057,00	
	P. 51	<b>13208072</b>	562,00	674,00	780,00	1.057,00	
	P. 62	<b>13208073</b>	597,00	713,00	830,00	1.136,00	
L. 140	P. 35	<b>13208074</b>	544,00	661,00	763,00	1.019,00	
	P. 46	<b>13208075</b>	609,00	735,00	850,00	1.151,00	
	P. 51	<b>13208076</b>	609,00	735,00	850,00	1.151,00	
	P. 62	<b>13208077</b>	646,00	777,00	903,00	1.233,00	

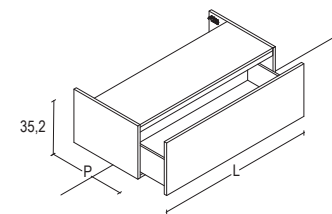

**ILLUMINAZIONE INTERNA DISPONIBILE**  
INTERNAL LIGHTING AVAILABLE

**! ATTENZIONE SUGGERITO L'UTILIZZO DEL SIFONE SALVASPAZIO**  
ATTENTION USE OF THE SPACE-SAVING SIPHON IS RECOMMENDED

**ESEMPIO**  
EXAMPLE

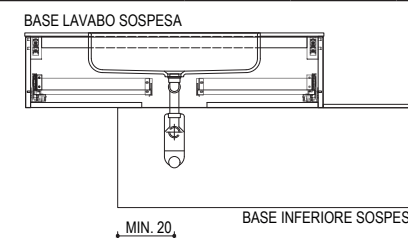

**FINITURE/FINISHES:**  
① NOBILITATO; ② LACCATO OPACO; ③ LACCATO LUCIDO; ④ LACCATO METALLO; ⑤ IMPIALLACCIATO; ⑥ HPL; ⑦ RESINA CEMENTO  
① MELAMINE; ② MATT LACQUERED; ③ GLOSSY LACQUERED; ④ METAL LACQUERED; ⑤ VENEREED WOOD; ⑥ HPL; ⑦ RESIN CEMENT

**FINITURE/FINISHES:**  
① NOBILITATO; ② LACCATO OPACO; ③ LACCATO LUCIDO; ④ LACCATO METALLO; ⑤ IMPIALLACCIATO; ⑥ HPL; ⑦ RESINA CEMENTO  
① MELAMINE; ② MATT LACQUERED; ③ GLOSSY LACQUERED; ④ METAL LACQUERED; ⑤ VENEREED WOOD; ⑥ HPL; ⑦ RESIN CEMENT

**AIRY SISTEMA | BASI SOSPESSE INFERIORI H. 35 DA PREVEDERE SOTTO BASE LAVABO**

AIRY SISTEMA  
WALL HUNG LOWER-BASES H. 35

**BASE INFERIORE A GIORNO**  
OPEN LOWER-BASE

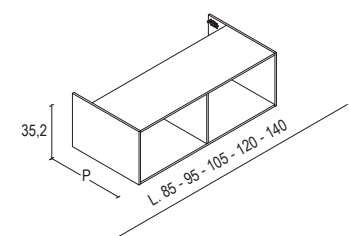
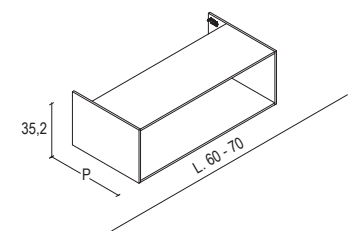

**! ATTENZIONE**  
**SUGGERITO L'UTILIZZO**  
**DEL SIFONE SALVASPAZIO**  
*!ATTENTION*  
*USE OF THE SPACE-SAVING*  
*SIPHON IS RECOMMENDED*

DIMENSIONI DIMENSIONS	CODICE CODE	①	②	③	④	⑤	⑥
L. 60	P. 35	<b>13317040</b>	205,00	354,00	424,00		
	P. 46	<b>13317041</b>	247,00	458,00	587,00		
	P. 51	<b>13317042</b>	247,00	458,00	587,00		
	P. 62	<b>13317043</b>	272,00	522,00	663,00		
L. 70	P. 35	<b>13317044</b>	238,00	430,00	471,00		
	P. 46	<b>13317045</b>	286,00	551,00	633,00		
	P. 51	<b>13317046</b>	286,00	551,00	633,00		
L. 85	P. 62	<b>13317047</b>	319,00	633,00	725,00		
	P. 35	<b>13317050</b>	261,00	477,00	522,00		
	P. 46	<b>13317051</b>	317,00	604,00	703,00		
L. 95	P. 51	<b>13317052</b>	317,00	604,00	703,00		
	P. 62	<b>13317053</b>	365,00	729,00	856,00		
	P. 35	<b>13317054</b>	278,00	507,00	555,00		
L. 105	P. 46	<b>13317055</b>	337,00	639,00	751,00		
	P. 51	<b>13317056</b>	337,00	639,00	751,00		
	P. 62	<b>13317057</b>	384,00	762,00	895,00		
L. 120	P. 35	<b>13317058</b>	312,00	567,00	621,00		
	P. 46	<b>13317059</b>	377,00	709,00	847,00		
	P. 51	<b>13317060</b>	377,00	709,00	847,00		
L. 140	P. 62	<b>13317061</b>	422,00	828,00	973,00		
	P. 35	<b>13317062</b>	335,00	614,00	672,00		
	P. 46	<b>13317063</b>	408,00	762,00	917,00		
L. 140	P. 51	<b>13317064</b>	408,00	762,00	917,00		
	P. 62	<b>13317065</b>	468,00	924,00	1.104,00		
	P. 35	<b>13317066</b>	369,00	674,00	738,00		
	P. 46	<b>13317067</b>	448,00	832,00	1.013,00		
L. 140	P. 51	<b>13317068</b>	448,00	832,00	1.013,00		
	P. 62	<b>13317069</b>	506,00	990,00	1.182,00		

**ESEMPIO**  
EXAMPLE

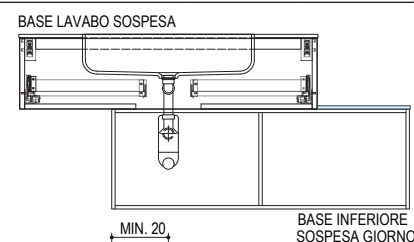

**FINITURE/FINISHES:**  
① NOBILITATO; ② LACCATO OPACO; ③ LACCATO LUCIDO; ④ LACCATO METALLO; ⑤ IMPIALLACCIATO; ⑥ HPL  
① MELAMINE; ② MATT LACQUERED; ③ GLOSSY LACQUERED; ④ METAL LACQUERED; ⑤ VENEREED WOOD; ⑥ HPL

**AIRY SISTEMA | BASI SOSPESSE H. 35**

AIRY SISTEMA  
WALL HUNG BASES H. 35

**BASE 1 ANTA**  
BASE 1 DOOR

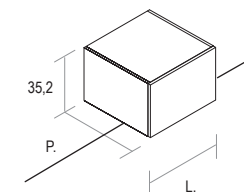

DIMENSIONI DIMENSIONS	CODICE CODE	①	②	③	④	⑤	⑥	⑦
L. 15	P. 35	<b>12001001</b>	178,00	209,00	254,00	370,00		
	P. 46	<b>12001002</b>	205,00	244,00	304,00	462,00		
	P. 51	<b>12001003</b>	205,00	244,00	304,00	462,00		
L. 20	P. 62	<b>12001050</b>	226,00	270,00	340,00	528,00		
	P. 35	<b>12001004</b>	178,00	209,00	254,00	370,00		
	P. 46	<b>12001005</b>	205,00	244,00	304,00	462,00		
L. 25	P. 51	<b>12001006</b>	205,00	244,00	304,00	462,00		
	P. 62	<b>12001051</b>	226,00	270,00	340,00	528,00		
	P. 35	<b>12001007</b>	178,00	209,00	254,00	370,00		
L. 30	P. 46	<b>12001008</b>	205,00	244,00	304,00	462,00		
	P. 51	<b>12001009</b>	205,00	244,00	304,00	462,00		
	P. 62	<b>12001052</b>	226,00	270,00	340,00	528,00		
L. 35	P. 35	<b>12001010</b>	194,00	232,00	282,00	409,00		
	P. 46	<b>12001011</b>	222,00	269,00	335,00	504,00		
	P. 51	<b>12001012</b>	222,00	269,00	335,00	504,00		
L. 50	P. 62	<b>12001053</b>	244,00	297,00	371,00	571,00		
	P. 35	<b>12001013</b>	194,00	232,00	282,00	409,00		
	P. 46	<b>12001014</b>	222,00	269,00	335,00	504,00		
L. 50	P. 51	<b>12001015</b>	222,00	269,00	335,00	504,00		
	P. 62	<b>12001054</b>	244,00	297,00	371,00	571,00		
	P. 35	<b>12001016</b>	217,00	266,00	325,00	468,00		
L. 50	P. 46	<b>12001017</b>	249,00	306,00	379,00	566,00		
	P. 51	<b>12001018</b>	249,00	306,00	379,00	566,00		
	P. 62	<b>12001055</b>	273,00	336,00	419,00	636,00		

**FINITURE/FINISHES:**  
① NOBILITATO; ② LACCATO OPACO; ③ LACCATO LUCIDO; ④ LACCATO METALLO; ⑤ IMPIALLACCIATO; ⑥ HPL; ⑦ RESINA CEMENTO  
① MELAMINE; ② MATT LACQUERED; ③ GLOSSY LACQUERED; ④ METAL LACQUERED; ⑤ VENEREED WOOD; ⑥ HPL; ⑦ RESIN CEMENT

## AIRY SISTEMA | BASI SOSPESSE H. 35

AIRY SISTEMA  
WALL HUNG BASES H. 35

**BASE A GIORNO**  
OPEN BASE

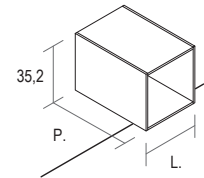

	DIMENSIONI DIMENSIONS	CODICE CODE	①	②	③ ④ ⑤ ⑥	⑦
L. 25	P. 35	<b>13017021</b>	151,00	250,00	280,00	-
	P. 46	<b>13017022</b>	180,00	322,00	359,00	-
	P. 51	<b>13017023</b>	180,00	322,00	359,00	-
	P. 62	<b>13017024</b>	188,00	351,00	448,00	-
L. 35	P. 35	<b>13017025</b>	165,00	277,00	340,00	-
	P. 46	<b>13017026</b>	196,00	370,00	469,00	-
	P. 51	<b>13017027</b>	196,00	370,00	469,00	-
	P. 62	<b>13017028</b>	207,00	393,00	493,00	-
L. 50	P. 35	<b>13017029</b>	188,00	324,00	391,00	-
	P. 46	<b>13017030</b>	227,00	423,00	539,00	-
	P. 51	<b>13017031</b>	227,00	423,00	539,00	-
	P. 62	<b>13017032</b>	253,00	489,00	624,00	-
L. 60	P. 35	<b>13017033</b>	205,00	354,00	424,00	-
	P. 46	<b>13017034</b>	247,00	458,00	587,00	-
	P. 51	<b>13017035</b>	247,00	458,00	587,00	-
	P. 62	<b>13017036</b>	272,00	522,00	663,00	-
L. 70	P. 35	<b>13017037</b>	238,00	430,00	471,00	-
	P. 46	<b>13017038</b>	286,00	551,00	633,00	-
	P. 51	<b>13017039</b>	286,00	551,00	633,00	-
	P. 62	<b>13017040</b>	319,00	633,00	725,00	-

**BASE A GIORNO PER CAMBIO  
DI PROFONDITÀ DX-SX**  
DEPTH-CHANGING OPEN BASE

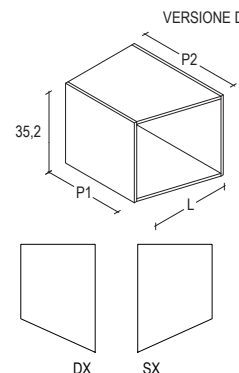

L. 25	P. 35 - 46	<b>13417015</b>	234,00	387,00	431,00	-
	P. 35 - 51	<b>13417016</b>	234,00	387,00	431,00	-
L. 35	P. 35 - 46	<b>13417017</b>	255,00	444,00	563,00	-
	P. 35 - 51	<b>13417018</b>	255,00	444,00	563,00	-
L. 50	P. 35 - 46	<b>13417019</b>	296,00	508,00	647,00	-
	P. 35 - 51	<b>13417020</b>	296,00	508,00	647,00	-

**BASE TERMINALE A GIORNO  
DX-SX**  
OPEN SIDE-BASE

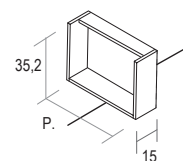

L. 15	P. 35	<b>12717001</b>	96,00	144,00	180,00	273,00*
	P. 46	<b>12717002</b>	119,00	182,00	232,00	355,00*
	P. 51	<b>12717003</b>	119,00	182,00	232,00	355,00*
	P. 62	<b>12717007</b>	136,00	210,00	267,00	412,00*

\*LA VARIANTE IN FINITURA RESINA CEMENTO E' DISPONIBILE SOLO PER IL FRONTALE, MENTRE LA PARTE A GIORNO INTERNA SARA' REALIZZATA IN UN'ALTRA FINITURA DA SPECIFICARE IN FASE D'ORDINE.

THE CEMENT RESIN FINISH IS AVAILABLE FOR FRONTS ONLY. THE FINISH OF THE SIDE-OPEN COMPARTMENT MUST BE SPECIFIED IN THE ORDER.

FINITURE/FINISHES:

① NOBILITATO; ② LACCATO OPACO; ③ LACCATO LUCIDO; ④ LACCATO METALLO; ⑤ IMPIALLACCIATO; ⑥ HPL; ⑦ RESINA CEMENTO

① MELAMINE; ② MATT LACQUERED; ③ GLOSSY LACQUERED; ④ METAL LACQUERED; ⑤ VENEREED WOOD; ⑥ HPL; ⑦ RESIN CEMENT





## AIRY SISTEMA BASI SOSPESSE H. 50 CURVE

AIRY SISTEMA

CURVED WALL HUNG BASES H. 50

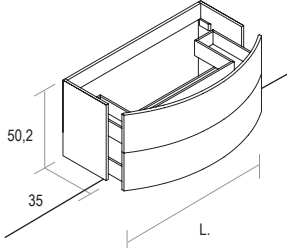
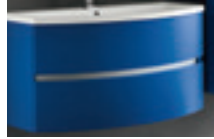
**AIRY SISTEMA | MANIGLIE PER BASI CURVE**

AIRY SISTEMA  
HANDLES FOR CURVED BASES

		CODICE CODE	
		<b>G3</b>	<b>OPZIONALE</b> OPTIONAL
		<b>Y12</b> <b>91520001</b>	<b>OPZIONALE</b> OPTIONAL <b>€ 46,00 CAD.</b> € 46,00 EACH
		<b>Y0</b> <b>91010001</b>	<b>€ 75,00 CAD.</b> € 75,00 EACH
		<b>Y0</b>	<b>OPZIONALE</b> OPTIONAL
		<b>Y0</b>	<b>OPZIONALE</b> OPTIONAL

**AIRY SISTEMA | BASI CURVE SOPPESE H. 50**

AIRY SISTEMA  
WALL HUNG CURVED BASES H.50

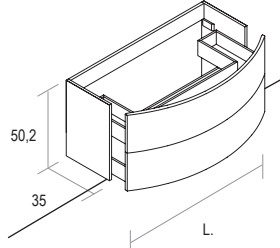
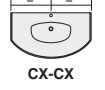
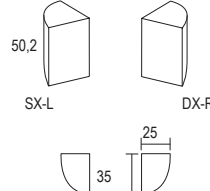
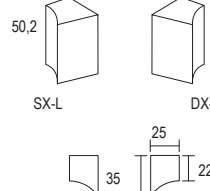
	DIMENSIONI DIMENSIONS	CODICE CODE	②	③ ④	⑦
<b>BASE LAVABO 2 CASSETTI</b> WASHBASIN BASE W/2 DRAWERS  	L. 85 P. 35 - 49	<b>12409001</b>	1.118,00	1.293,00	1.530,00
<b>ILLUMINAZIONE INTERNA DISPONIBILE</b> INTERNAL LIGHTING AVAILABLE  <b>POSIZIONE LAVABO</b> WASHBASIN POSITION 	L. 105 P. 35 - 49	<b>12409002</b>	1.223,00	1.444,00	1.685,00
<b>BASE 1 ANTA TERMINALE CURVA</b> ENDING CURVED BASE W/1 DOOR  	L. 25 P. 0 - 35	<b>12901001</b>	355,00	401,00	452,00
<b>BASE 1 ANTA DI RACCORDO CONVESSA</b> CONNECTING CONVEX BASE W/1 DOOR  	L. 25 P. 22 - 35	<b>12901002</b>	355,00	401,00	452,00

**FINITURE/FINISHES:**  
 ② LACCATO OPACO; ③ LACCATO LUCIDO; ④ LACCATO METALLO; ⑦ RESINA CEMENTO  
 ② MATT LACQUERED; ③ GLOSSY LACQUERED; ④ METAL LACQUERED; ⑦ RESIN CEMENT

**AIRY SISTEMA**  
**BASI SOSPESSE H. 50**

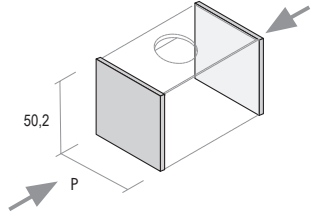
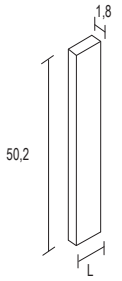

*AIRY SISTEMA*  
*WALL HUNG BASES H. 50*

**AIRY SISTEMA | ACCESSORI PER BASI H. 50 - OPZIONALI**

AIRY SISTEMA ACCESSORIES FOR BASES H. 50	DIMENSIONI DIMENSIONS	CODICE CODE	①	②	③ ④ ⑤ ⑥	⑦
<b>FIANCO DI FINITURA SP. 1,2</b> ADDITIONAL FINISHING SIDE-PANEL TH. 1.2 	P. 35	<b>19000007</b>	83,00	120,00	136,00	270,00
	P. 46	<b>19000009</b>	101,00	147,00	173,00	347,00
	P. 51	<b>19000010</b>	101,00	147,00	173,00	347,00
	P. 62	<b>19000024</b>	105,00	156,00	200,00	450,00
<b>N.B. I PREZZI SI RIFERISCONO AD UN SINGOLO FIANCO</b> N.B. : THE PRICES REFER TO A SINGLE SIDE-PANEL						
<b>FASCIA DI TAMPONAMENTO PER BASE H. 50</b> FILLER WOODEN-STRIP FOR BASES H.50 	H. 50 L. 5 - 15	<b>19126007</b>	71,00	106,00	116,00	186,00
<b>N.B. MISURA MINIMA L. 5 CM E MASSIMA L. 15 CM</b> N.B. MIN. L. 5 CM AND MAX L. 15 CM						

**FINITURE/FINISHES:**  
 ① NOBILITATO; ② LACCATO OPACO; ③ LACCATO LUCIDO; ④ LACCATO METALLO; ⑤ IMPIALLACCIATO; ⑥ HPL; ⑦ RESINA CEMENTO  
 ① MELAMINE; ② MATT LACQUERED; ③ GLOSSY LACQUERED; ④ METAL LACQUERED; ⑤ VENEREED WOOD; ⑥ HPL; ⑦ RESIN CEMENT

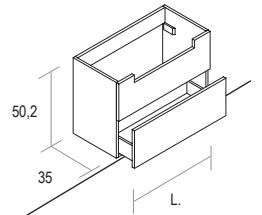
**AIRY SISTEMA | BASI SOSPESSE H. 50**

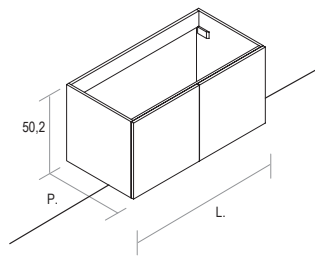
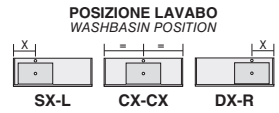
AIRY SISTEMA WALL HUNG BASES H. 50	DIMENSIONI DIMENSIONS	CODICE CODE	①	②	③ ④ ⑤ ⑥	⑦
<b>BASE LAVABO FRONTALE FISSO + 1 CASSETTO</b> WASHBASIN BASE W/1 FIXED FRONT + 1 DRAWER 	L. 70 P. 35	<b>12614001</b>	390,00	484,00	582,00	825,00
	L. 85 P. 35	<b>12614002</b>	412,00	517,00	622,00	882,00
	L. 95 P. 35	<b>12614003</b>	431,00	546,00	658,00	934,00
	L. 105 P. 35	<b>12614010</b>	446,00	571,00	691,00	981,00
<b>ILLUMINAZIONE INTERNA DISPONIBILE</b> INTERNAL LIGHTING AVAILABLE <b>POSIZIONE LAVABO</b> WASHBASIN POSITION 						
<b>BASE LAVABO 2 ANTE</b> WASHBASIN BASE W/2 DOORS 	L. 60 P. 35	<b>12106060</b>	270,00	353,00	444,00	668,00
	L. 60 P. 46	<b>12106001</b>	310,00	406,00	517,00	802,00
	L. 60 P. 51	<b>12106002</b>	310,00	406,00	517,00	802,00
	L. 60 P. 62	<b>12106010</b>	336,00	440,00	564,00	894,00
	L. 70 P. 35	<b>12106061</b>	273,00	368,00	465,00	706,00
	L. 70 P. 46	<b>12106003</b>	327,00	434,00	551,00	854,00
	L. 70 P. 51	<b>12106004</b>	327,00	434,00	551,00	854,00
	L. 70 P. 62	<b>12106011</b>	354,00	469,00	600,00	947,00
	L. 85 P. 35	<b>12106062</b>	314,00	426,00	533,00	801,00
	L. 85 P. 46	<b>12106005</b>	370,00	494,00	622,00	950,00
	L. 85 P. 51	<b>12106006</b>	370,00	494,00	622,00	950,00
	L. 85 P. 62	<b>12106012</b>	391,00	523,00	665,00	1.037,00
<b>POSIZIONE LAVABO</b> WASHBASIN POSITION 						
	L. 95 P. 35	<b>12106063</b>	332,00	453,00	568,00	852,00
	L. 95 P. 46	<b>12106013</b>	391,00	524,00	660,00	1.005,00
	L. 95 P. 51	<b>12106014</b>	391,00	524,00	660,00	1.005,00
L. 95 P. 62	<b>12106015</b>	411,00	555,00	704,00	1.092,00	
	L. 100 P. 35	<b>12106064</b>	335,00	463,00	582,00	873,00
	L. 100 P. 46	<b>12106007</b>	400,00	539,00	679,00	1.032,00
	L. 100 P. 51	<b>12106008</b>	400,00	539,00	679,00	1.032,00
	L. 100 P. 62	<b>12106016</b>	434,00	583,00	736,00	1.134,00
	L. 105 P. 35	<b>12106065</b>	341,00	476,00	599,00	900,00
	L. 105 P. 46	<b>12106017</b>	408,00	555,00	697,00	1.060,00
	L. 105 P. 51	<b>12106018</b>	408,00	555,00	697,00	1.060,00
L. 105 P. 62	<b>12106019</b>	445,00	599,00	756,00	1.162,00	

**FINITURE/FINISHES:**  
 ① NOBILITATO; ② LACCATO OPACO; ③ LACCATO LUCIDO; ④ LACCATO METALLO; ⑤ IMPIALLACCIATO; ⑥ HPL; ⑦ RESINA CEMENTO  
 ① MELAMINE; ② MATT LACQUERED; ③ GLOSSY LACQUERED; ④ METAL LACQUERED; ⑤ VENEREED WOOD; ⑥ HPL; ⑦ RESIN CEMENT

**AIRY SISTEMA | BASI SOSPESA H. 50**

AIRY SISTEMA  
WALL HUNG BASES H. 50

	DIMENSIONI DIMENSIONS	CODICE CODE	①	②	③ ④ ⑤ ⑥	⑦	
<b>BASE LAVABO 2 CASSETTI</b> WASHBASIN BASE W/2 DRAWERS	L. 60	P. 35	12109001	570,00	657,00	746,00	982,00
		P. 46	12109002	622,00	721,00	828,00	1.128,00
		P. 51	12109003	622,00	721,00	828,00	1.128,00
		P. 62	12109020	652,00	759,00	881,00	1.223,00
	L. 70	P. 35	12109004	595,00	693,00	789,00	1.043,00
		P. 46	12109005	653,00	763,00	878,00	1.195,00
		P. 51	12109006	653,00	763,00	878,00	1.195,00
		P. 62	12109021	680,00	800,00	928,00	1.288,00
	L. 85	P. 35	12109007	658,00	773,00	878,00	1.161,00
		P. 46	12109008	720,00	848,00	974,00	1.318,00
		P. 51	12109009	720,00	848,00	974,00	1.318,00
		P. 62	12109022	753,00	889,00	1.029,00	1.415,00
L. 95	P. 35	12109023	688,00	816,00	928,00	1.228,00	
	P. 46	12109024	758,00	898,00	1.030,00	1.391,00	
	P. 51	12109025	758,00	898,00	1.030,00	1.391,00	
	P. 62	12109026	790,00	937,00	1.083,00	1.489,00	
L. 105	P. 35	12109010	719,00	856,00	976,00	1.294,00	
	P. 46	12109011	780,00	931,00	1.070,00	1.448,00	
	P. 51	12109012	780,00	931,00	1.070,00	1.448,00	
	P. 62	12109027	816,00	975,00	1.128,00	1.551,00	
L. 120	P. 35	12109013	762,00	917,00	1.047,00	1.391,00	
	P. 46	12109014	839,00	1.005,00	1.156,00	1.562,00	
	P. 51	12109015	839,00	1.005,00	1.156,00	1.562,00	
	P. 62	12109029	859,00	1.036,00	1.199,00	1.648,00	
L. 140	P. 35	12109016	824,00	1.002,00	1.146,00	1.524,00	
	P. 46	12109017	899,00	1.090,00	1.253,00	1.695,00	
	P. 51	12109018	899,00	1.090,00	1.253,00	1.695,00	
	P. 62	12109030	948,00	1.149,00	1.325,00	1.810,00	

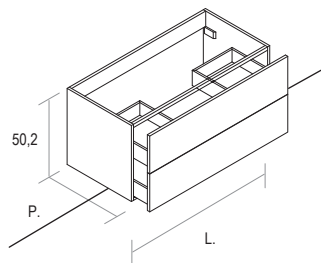

**ILLUMINAZIONE INTERNA DISPONIBILE**  
INTERNAL LIGHTING AVAILABLE



**AIRY SISTEMA | BASI SOSPESA H. 50**

AIRY SISTEMA  
WALL HUNG BASES H. 50

	DIMENSIONI DIMENSIONS	CODICE CODE	①	②	③ ④ ⑤ ⑥	⑦	
<b>BASE LAVABO 1 CASSETTONE + CASSETTO INTERNO H. 10</b> BASE W/1 DRAWER + 1 INTERNAL DRAWER H. 10	L. 60	P. 35	12125033	570,00	657,00	746,00	982,00
		P. 46	12125034	622,00	721,00	828,00	1.128,00
		P. 51	12125035	622,00	721,00	828,00	1.128,00
		P. 62	12125036	652,00	759,00	881,00	1.223,00
	L. 70	P. 35	12125037	595,00	693,00	789,00	1.043,00
		P. 46	12125038	653,00	763,00	878,00	1.195,00
		P. 51	12125039	653,00	763,00	878,00	1.195,00
		P. 62	12125040	680,00	800,00	928,00	1.288,00
	L. 85	P. 35	12125041	658,00	773,00	878,00	1.161,00
		P. 46	12125042	720,00	848,00	974,00	1.318,00
		P. 51	12125043	720,00	848,00	974,00	1.318,00
		P. 62	12125044	753,00	889,00	1.029,00	1.415,00
L. 95	P. 35	12125045	688,00	816,00	928,00	1.228,00	
	P. 46	12125046	758,00	898,00	1.030,00	1.391,00	
	P. 51	12125047	758,00	898,00	1.030,00	1.391,00	
	P. 62	12125048	790,00	937,00	1.083,00	1.489,00	
L. 105	P. 35	12125049	719,00	856,00	976,00	1.294,00	
	P. 46	12125050	780,00	931,00	1.070,00	1.448,00	
	P. 51	12125051	780,00	931,00	1.070,00	1.448,00	
	P. 62	12125052	816,00	975,00	1.128,00	1.551,00	
L. 120	P. 35	12125053	762,00	917,00	1.047,00	1.391,00	
	P. 46	12125054	839,00	1.005,00	1.156,00	1.562,00	
	P. 51	12125055	839,00	1.005,00	1.156,00	1.562,00	
	P. 62	12125056	859,00	1.036,00	1.199,00	1.648,00	
L. 140	P. 35	12125057	824,00	1.002,00	1.146,00	1.524,00	
	P. 46	12125058	899,00	1.090,00	1.253,00	1.695,00	
	P. 51	12125059	899,00	1.090,00	1.253,00	1.695,00	
	P. 62	12125060	948,00	1.149,00	1.325,00	1.810,00	

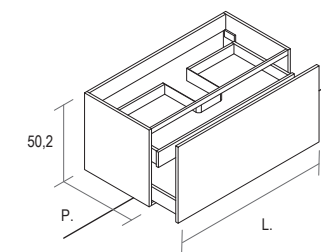

**ILLUMINAZIONE INTERNA DISPONIBILE**  
INTERNAL LIGHTING AVAILABLE

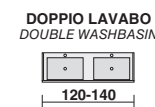
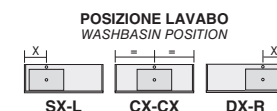

**AIRY SISTEMA | BASI SOSPESSE H. 50**

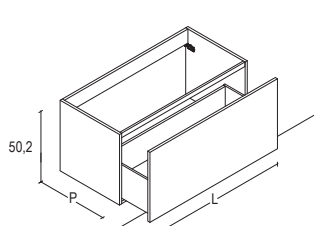
AIRY SISTEMA WALL HUNG BASES H. 50		DIMENSIONI DIMENSIONS	CODICE CODE	①	②	③ ④ ⑤ ⑥	⑦
	<b>BASE LAVABO 1 CASSETTONE</b> WASHBASIN BASE W/1 DRAWER	P. 35	<b>12108101</b>	443,00	521,00	609,00	841,00
		P. 46	<b>12108102</b>	486,00	581,00	686,00	984,00
		P. 51	<b>12108103</b>	486,00	581,00	686,00	984,00
		P. 62	<b>12108104</b>	516,00	619,00	739,00	1.079,00
	L. 60	P. 35	<b>12108105</b>	456,00	546,00	641,00	892,00
		P. 46	<b>12108106</b>	504,00	611,00	725,00	1.037,00
		P. 51	<b>12108107</b>	504,00	611,00	725,00	1.037,00
		P. 62	<b>12108108</b>	531,00	648,00	775,00	1.130,00
	L. 70	P. 35	<b>12108109</b>	503,00	612,00	715,00	993,00
		P. 46	<b>12108110</b>	553,00	679,00	804,00	1.143,00
		P. 51	<b>12108111</b>	553,00	679,00	804,00	1.143,00
		P. 62	<b>12108112</b>	586,00	720,00	859,00	1.240,00
L. 85	P. 35	<b>12108113</b>	522,00	645,00	755,00	1.050,00	
	P. 46	<b>12108114</b>	579,00	717,00	849,00	1.204,00	
	P. 51	<b>12108115</b>	579,00	717,00	849,00	1.204,00	
	P. 62	<b>12108116</b>	611,00	756,00	902,00	1.302,00	
L. 95	P. 35	<b>12108117</b>	541,00	674,00	792,00	1.106,00	
	P. 46	<b>12108118</b>	588,00	738,00	878,00	1.247,00	
	P. 51	<b>12108119</b>	588,00	738,00	878,00	1.247,00	
	P. 62	<b>12108120</b>	624,00	782,00	936,00	1.350,00	
L. 105	P. 35	<b>12108121</b>	574,00	719,00	848,00	1.186,00	
	P. 46	<b>12108122</b>	637,00	795,00	945,00	1.345,00	
	P. 51	<b>12108123</b>	637,00	795,00	945,00	1.345,00	
	P. 62	<b>12108124</b>	657,00	826,00	988,00	1.431,00	
L. 120	P. 35	<b>12108125</b>	611,00	782,00	925,00	1.297,00	
	P. 46	<b>12108126</b>	668,00	857,00	1.020,00	1.453,00	
	P. 51	<b>12108127</b>	668,00	857,00	1.020,00	1.453,00	
	P. 62	<b>12108128</b>	717,00	916,00	1.092,00	1.568,00	
L. 140	P. 35	<b>12108125</b>	611,00	782,00	925,00	1.297,00	
	P. 46	<b>12108126</b>	668,00	857,00	1.020,00	1.453,00	
	P. 51	<b>12108127</b>	668,00	857,00	1.020,00	1.453,00	
	P. 62	<b>12108128</b>	717,00	916,00	1.092,00	1.568,00	

 **ILLUMINAZIONE INTERNA DISPONIBILE**  
INTERNAL LIGHTING AVAILABLE

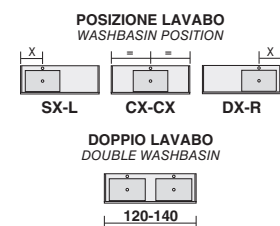

**FINITURE/FINISHES:**  
 ① NOBILITATO; ② LACCATO OPACO; ③ LACCATO LUCIDO; ④ LACCATO METALLO; ⑤ IMPIALLACCIATO; ⑥ HPL; ⑦ RESINA CEMENTO  
 ① MELAMINE; ② MATT LACQUERED; ③ GLOSSY LACQUERED; ④ METAL LACQUERED; ⑤ VENEREED WOOD; ⑥ HPL; ⑦ RESIN CEMENT

**AIRY SISTEMA | BASI SOSPESSE H. 50**

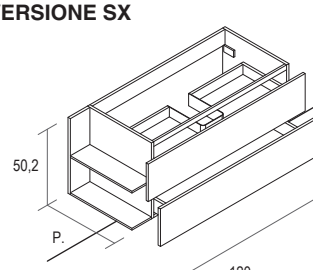
AIRY SISTEMA WALL HUNG BASES H. 50		DIMENSIONI DIMENSIONS	CODICE CODE	①	②	③ ④ ⑤ ⑥	⑦
	<b>BASE LAVABO 2 CASSETTI E VANO A GIORNO LATERALE DX-SX L.15</b> WASHBASIN BASE 2 DRAWERS WITH LATERAL L-R OPEN BASE W. 15	P. 35	<b>12018001D</b>	825,00	1.014,00	1.163,00	1.512,00*
			<b>12018001S</b>	825,00	1.014,00	1.163,00	1.512,00*
		P. 46	<b>12018002D</b>	900,00	1.113,00	1.289,00	1.693,00*
			<b>12018002S</b>	900,00	1.113,00	1.289,00	1.693,00*
	L. 120	P. 51	<b>12018003D</b>	900,00	1.113,00	1.289,00	1.693,00*
			<b>12018003S</b>	900,00	1.113,00	1.289,00	1.693,00*
		P. 62	<b>12018005D</b>	934,00	1.165,00	1.359,00	1.801,00*
			<b>12018005S</b>	934,00	1.165,00	1.359,00	1.801,00*

 **ILLUMINAZIONE INTERNA DISPONIBILE**  
INTERNAL LIGHTING AVAILABLE



**! ATTENZIONE**  
**NON UTILIZZABILE CON:**  
 - CONSOLLE IN CERAMICA  
 - GOLA G3  
 !ATTENTION DO NOT USE:  
 - CERAMIC CONSOLE  
 - G3 GROOVE



**\* VANO A GIORNO LATERALE NON DISPONIBILE NELLA FINITURA RESINA CEMENTO. SPECIFICARE IN FASE D'ORDINE LA FINITURA SCELTA.**

*\* SIDE OPEN COMPARTMENT NOT AVAILABLE IN CEMENT RESIN FINISH. SPECIFY THE CHOSEN FINISH IN THE ORDER.*

**FINITURE/FINISHES:**  
 ① NOBILITATO; ② LACCATO OPACO; ③ LACCATO LUCIDO; ④ LACCATO METALLO; ⑤ IMPIALLACCIATO; ⑥ HPL; ⑦ RESINA CEMENTO  
 ① MELAMINE; ② MATT LACQUERED; ③ GLOSSY LACQUERED; ④ METAL LACQUERED; ⑤ VENEREED WOOD; ⑥ HPL; ⑦ RESIN CEMENT

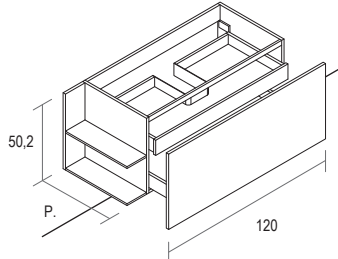

**AIRY SISTEMA | BASI SOSPESSE H. 50**



AIRY SISTEMA WALL HUNG BASES H.50		DIMENSIONI DIMENSIONS	CODICE CODE	①	②	③ ④ ⑤ ⑥	⑦
<b>BASE LAVABO 1 CASSETTONE + CASSETTO INTERNO H. 10 E VANO A GIORNO LATERALE DX-SX L. 15</b> WASHBASIN BASE W/2 DRAWERS AND ONE-SIDE SHELVES (R / L VERSION) <b>VERSIONE SX</b>   <b>! ATTENZIONE NON UTILIZZABILE CON: - CONSOLLE IN CERAMICA - GOLA G3</b> !ATTENTION DO NOT USE: - CERAMIC CONSOLE - G3 GROOVE	P. 35	<b>12137001D</b>	825,00	1.014,00	1.163,00	1.512,00	
		<b>12137001S</b>	825,00	1.014,00	1.163,00	1.512,00	
	P. 46	<b>12137002D</b>	900,00	1.113,00	1.289,00	1.693,00	
		<b>12137002S</b>	900,00	1.113,00	1.289,00	1.693,00	
	L. 120	<b>12137003D</b>	900,00	1.113,00	1.289,00	1.693,00	
		<b>12137003S</b>	900,00	1.113,00	1.289,00	1.693,00	
	P. 51	<b>12137004D</b>	934,00	1.165,00	1.359,00	1.801,00	
		<b>12137004S</b>	934,00	1.165,00	1.359,00	1.801,00	
	P. 62	<b>12137005D</b>	900,00	1.113,00	1.289,00	1.693,00	
		<b>12137005S</b>	900,00	1.113,00	1.289,00	1.693,00	

\* VANO A GIORNO LATERALE NON DISPONIBILE NELLA FINITURA RESINA CEMENTO. SPECIFICARE IN FASE D'ORDINE LA FINITURA SCELTA.

\* SIDE OPEN COMPARTMENT NOT AVAILABLE IN CEMENT RESIN FINISH. SPECIFY THE CHOSEN FINISH IN THE ORDER.

**FINITURE/FINISHES:**  
 ① NOBILITATO; ② LACCATO OPACO; ③ LACCATO LUCIDO; ④ LACCATO METALLO; ⑤ IMPIALLACCIATO; ⑥ HPL; ⑦ RESINA CEMENTO  
 ① MELAMINE; ② MATT LACQUERED; ③ GLOSSY LACQUERED; ④ METAL LACQUERED; ⑤ VENEREED WOOD; ⑥ HPL; ⑦ RESIN CEMENT

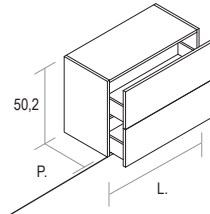
**AIRY SISTEMA | BASI SOSPESSE H. 50**

AIRY SISTEMA WALL HUNG BASES H.50		DIMENSIONI DIMENSIONS	CODICE CODE	①	②	③ ④ ⑤ ⑥	⑦
<b>BASE 2 CASSETTI</b> BASE W/2 DRAWERS   <b>! ATTENZIONE NON UTILIZZABILE CON: - CONSOLLE IN CERAMICA - GOLA G3</b> !ATTENTION DO NOT USE: - CERAMIC CONSOLE - G3 GROOVE	L. 25	P. 35	<b>12009001</b>	411,00	458,00	523,00	696,00
		P. 46	<b>12009002</b>	452,00	510,00	594,00	830,00
		P. 51	<b>12009003</b>	452,00	510,00	594,00	830,00
	L. 35	P. 62	<b>12009031</b>	475,00	544,00	642,00	918,00
		P. 35	<b>12009004</b>	439,00	496,00	567,00	758,00
		P. 46	<b>12009005</b>	484,00	554,00	644,00	896,00
	L. 50	P. 51	<b>12009006</b>	484,00	554,00	644,00	896,00
		P. 62	<b>12009032</b>	508,00	588,00	692,00	987,00
		P. 35	<b>12009007</b>	482,00	556,00	637,00	855,00
	L. 60	P. 46	<b>12009008</b>	522,00	609,00	710,00	989,00
		P. 51	<b>12009009</b>	522,00	609,00	710,00	989,00
		P. 62	<b>12009033</b>	549,00	646,00	759,00	1.081,00
	L. 70	P. 35	<b>12009010</b>	508,00	595,00	685,00	920,00
		P. 46	<b>12009011</b>	561,00	660,00	769,00	1.065,00
		P. 51	<b>12009012</b>	561,00	660,00	769,00	1.065,00
	L. 85	P. 62	<b>12009034</b>	590,00	698,00	819,00	1.161,00
		P. 35	<b>12009013</b>	535,00	633,00	729,00	981,00
		P. 46	<b>12009014</b>	593,00	703,00	818,00	1.133,00
	L. 95	P. 51	<b>12009015</b>	593,00	703,00	818,00	1.133,00
		P. 62	<b>12009035</b>	620,00	740,00	868,00	1.226,00
		P. 35	<b>12009016</b>	589,00	704,00	811,00	1.090,00
	L. 105	P. 46	<b>12009017</b>	652,00	779,00	905,00	1.247,00
		P. 51	<b>12009018</b>	652,00	779,00	905,00	1.247,00
		P. 62	<b>12009036</b>	685,00	821,00	960,00	1.346,00
L. 120	P. 35	<b>12009037</b>	619,00	746,00	857,00	1.156,00	
	P. 46	<b>12009038</b>	686,00	824,00	958,00	1.316,00	
	P. 51	<b>12009039</b>	686,00	824,00	958,00	1.316,00	
L. 140	P. 62	<b>12009040</b>	720,00	868,00	1.014,00	1.417,00	
	P. 35	<b>12009019</b>	635,00	773,00	894,00	1.206,00	
	P. 46	<b>12009020</b>	709,00	859,00	998,00	1.375,00	
L. 155	P. 51	<b>12009021</b>	709,00	859,00	998,00	1.375,00	
	P. 62	<b>12009041</b>	745,00	904,00	1.057,00	1.477,00	
	P. 35	<b>12009022</b>	690,00	844,00	975,00	1.316,00	
L. 170	P. 46	<b>12009023</b>	764,00	933,00	1.081,00	1.485,00	
	P. 51	<b>12009024</b>	764,00	933,00	1.081,00	1.485,00	
	P. 62	<b>12009042</b>	803,00	978,00	1.142,00	1.589,00	
L. 185	P. 35	<b>12009025</b>	748,00	927,00	1.070,00	1.447,00	
	P. 46	<b>12009026</b>	830,00	1.019,00	1.184,00	1.621,00	
	P. 51	<b>12009027</b>	830,00	1.019,00	1.184,00	1.621,00	
P. 62	<b>12009043</b>	871,00	1.069,00	1.247,00	1.730,00		

**FINITURE/FINISHES:**  
 ① NOBILITATO; ② LACCATO OPACO; ③ LACCATO LUCIDO; ④ LACCATO METALLO; ⑤ IMPIALLACCIATO; ⑥ HPL; ⑦ RESINA CEMENTO  
 ① MELAMINE; ② MATT LACQUERED; ③ GLOSSY LACQUERED; ④ METAL LACQUERED; ⑤ VENEREED WOOD; ⑥ HPL; ⑦ RESIN CEMENT

## AIRY SISTEMA | BASI SOSPESSE H. 50

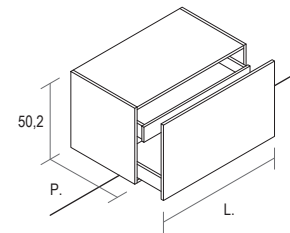
AIRY SISTEMA  
WALL HUNG BASES H.50**BASE 1 CASSETTONE  
+ CASSETTO INTERNO H. 10**  
BASE W/1 DRAWER + 1 INTERNAL  
DRAWER H. 10
**ILLUMINAZIONE INTERNA  
DISPONIBILE**  
INTERNAL LIGHTING AVAILABLE

DIMENSIONI DIMENSIONS	CODICE CODE	①	②	③ ④ ⑤ ⑥	⑦	
L. 25	P. 35	<b>12025046</b>	411,00	458,00	523,00	696,00
	P. 46	<b>12025047</b>	452,00	510,00	594,00	830,00
	P. 51	<b>12025048</b>	452,00	510,00	594,00	830,00
L. 35	P. 62	<b>12025049</b>	475,00	544,00	642,00	918,00
	P. 35	<b>12025050</b>	439,00	496,00	567,00	758,00
	P. 46	<b>12025051</b>	484,00	554,00	644,00	896,00
L. 50	P. 51	<b>12025052</b>	484,00	554,00	644,00	896,00
	P. 62	<b>12025053</b>	508,00	588,00	692,00	987,00
	P. 35	<b>12025054</b>	482,00	556,00	637,00	855,00
L. 60	P. 46	<b>12025055</b>	522,00	609,00	710,00	989,00
	P. 51	<b>12025056</b>	522,00	609,00	710,00	989,00
	P. 62	<b>12025057</b>	549,00	646,00	759,00	1.081,00
L. 70	P. 35	<b>12025058</b>	508,00	595,00	685,00	920,00
	P. 46	<b>12025059</b>	561,00	660,00	769,00	1.065,00
	P. 51	<b>12025060</b>	561,00	660,00	769,00	1.065,00
L. 85	P. 62	<b>12025061</b>	590,00	698,00	819,00	1.161,00
	P. 35	<b>12025062</b>	535,00	633,00	729,00	981,00
	P. 46	<b>12025063</b>	593,00	703,00	818,00	1.133,00
L. 95	P. 51	<b>12025064</b>	593,00	703,00	818,00	1.133,00
	P. 62	<b>12025065</b>	620,00	740,00	868,00	1.226,00
	P. 35	<b>12025066</b>	589,00	704,00	811,00	1.090,00
L. 105	P. 46	<b>12025067</b>	652,00	779,00	905,00	1.247,00
	P. 51	<b>12025068</b>	652,00	779,00	905,00	1.247,00
	P. 62	<b>12025069</b>	685,00	821,00	960,00	1.346,00
L. 120	P. 35	<b>12025070</b>	619,00	746,00	857,00	1.156,00
	P. 46	<b>12025071</b>	686,00	824,00	958,00	1.316,00
	P. 51	<b>12025072</b>	686,00	824,00	958,00	1.316,00
L. 140	P. 62	<b>12025073</b>	720,00	868,00	1.014,00	1.417,00
	P. 35	<b>12025074</b>	635,00	773,00	894,00	1.206,00
	P. 46	<b>12025075</b>	709,00	859,00	998,00	1.375,00
L. 120	P. 51	<b>12025076</b>	709,00	859,00	998,00	1.375,00
	P. 62	<b>12025077</b>	745,00	904,00	1.057,00	1.477,00
	P. 35	<b>12025078</b>	690,00	844,00	975,00	1.316,00
L. 120	P. 46	<b>12025079</b>	764,00	933,00	1.081,00	1.485,00
	P. 51	<b>12025080</b>	764,00	933,00	1.081,00	1.485,00
	P. 62	<b>12025081</b>	803,00	978,00	1.142,00	1.589,00
L. 140	P. 35	<b>12025082</b>	748,00	927,00	1.070,00	1.447,00
	P. 46	<b>12025083</b>	830,00	1.019,00	1.184,00	1.621,00
	P. 51	<b>12025084</b>	830,00	1.019,00	1.184,00	1.621,00
L. 140	P. 62	<b>12025085</b>	871,00	1.069,00	1.247,00	1.730,00

## FINITURE/FINISHES:

 ① NOBILITATO; ② LACCATO OPACO; ③ LACCATO LUCIDO; ④ LACCATO METALLO; ⑤ IMPIALLACCIATO; ⑥ HPL; ⑦ RESINA CEMENTO  
 ① MELAMINE; ② MATT LACQUERED; ③ GLOSSY LACQUERED; ④ METAL LACQUERED; ⑤ VENEREED WOOD; ⑥ HPL; ⑦ RESIN CEMENT

## AIRY SISTEMA | BASI SOSPESSE H. 50

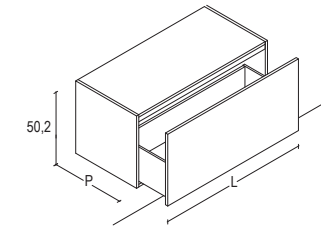
AIRY SISTEMA  
WALL HUNG BASES H.50**BASE 1 CASSETTONE**  
BASE W/1 DRAWER
**ILLUMINAZIONE INTERNA  
DISPONIBILE**  
INTERNAL LIGHTING AVAILABLE

DIMENSIONI DIMENSIONS	CODICE CODE	①	②	③ ④ ⑤ ⑥	⑦	
L. 25	P. 35	<b>12008101</b>	314,00	359,00	423,00	594,00
	P. 46	<b>12008102</b>	353,00	413,00	496,00	730,00
	P. 51	<b>12008103</b>	353,00	413,00	496,00	730,00
L. 35	P. 62	<b>12008104</b>	378,00	447,00	545,00	817,00
	P. 35	<b>12008105</b>	329,00	384,00	457,00	644,00
	P. 46	<b>12008106</b>	370,00	442,00	533,00	778,00
L. 50	P. 51	<b>12008107</b>	370,00	442,00	533,00	778,00
	P. 62	<b>12008108</b>	396,00	474,00	578,00	869,00
	P. 35	<b>12008109</b>	356,00	430,00	512,00	725,00
L. 60	P. 46	<b>12008110</b>	393,00	478,00	580,00	855,00
	P. 51	<b>12008111</b>	393,00	478,00	580,00	855,00
	P. 62	<b>12008112</b>	419,00	516,00	629,00	947,00
L. 70	P. 35	<b>12008113</b>	372,00	458,00	548,00	779,00
	P. 46	<b>12008114</b>	420,00	519,00	627,00	920,00
	P. 51	<b>12008115</b>	420,00	519,00	627,00	920,00
L. 85	P. 62	<b>12008116</b>	448,00	557,00	677,00	1.017,00
	P. 35	<b>12008117</b>	389,00	488,00	583,00	830,00
	P. 46	<b>12008118</b>	440,00	550,00	665,00	975,00
L. 95	P. 51	<b>12008119</b>	440,00	550,00	665,00	975,00
	P. 62	<b>12008120</b>	469,00	587,00	717,00	1.068,00
	P. 35	<b>12008121</b>	426,00	542,00	649,00	923,00
L. 105	P. 46	<b>12008122</b>	482,00	608,00	737,00	1.070,00
	P. 51	<b>12008123</b>	482,00	608,00	737,00	1.070,00
	P. 62	<b>12008124</b>	493,00	630,00	768,00	1.149,00
L. 120	P. 35	<b>12008125</b>	446,00	573,00	684,00	977,00
	P. 46	<b>12008126</b>	505,00	642,00	777,00	1.128,00
	P. 51	<b>12008127</b>	505,00	642,00	777,00	1.128,00
L. 120	P. 62	<b>12008128</b>	539,00	686,00	833,00	1.230,00
	P. 35	<b>12008129</b>	451,00	590,00	710,00	1.017,00
	P. 46	<b>12008130</b>	517,00	667,00	806,00	1.176,00
L. 140	P. 51	<b>12008131</b>	517,00	667,00	806,00	1.176,00
	P. 62	<b>12008132</b>	553,00	712,00	865,00	1.279,00
	P. 35	<b>12008133</b>	507,00	660,00	792,00	1.126,00
L. 120	P. 46	<b>12008134</b>	570,00	741,00	889,00	1.287,00
	P. 51	<b>12008135</b>	570,00	741,00	889,00	1.287,00
	P. 62	<b>12008136</b>	593,00	769,00	934,00	1.372,00
L. 140	P. 35	<b>12008137</b>	529,00	706,00	850,00	1.218,00
	P. 46	<b>12008138</b>	599,00	788,00	951,00	1.382,00
	P. 51	<b>12008139</b>	599,00	788,00	951,00	1.382,00
L. 140	P. 62	<b>12008140</b>	640,00	837,00	1.015,00	1.489,00

## FINITURE/FINISHES:

 ① NOBILITATO; ② LACCATO OPACO; ③ LACCATO LUCIDO; ④ LACCATO METALLO; ⑤ IMPIALLACCIATO; ⑥ HPL; ⑦ RESINA CEMENTO  
 ① MELAMINE; ② MATT LACQUERED; ③ GLOSSY LACQUERED; ④ METAL LACQUERED; ⑤ VENEREED WOOD; ⑥ HPL; ⑦ RESIN CEMENT

## AIRY SISTEMA | BASI SOSPESE H. 50

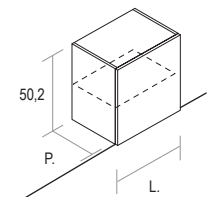
AIRY SISTEMA  
WALL HUNG BASES H.50BASE 1 ANTA  
BASE W/1 DOOR

DIMENSIONI DIMENSIONS	CODICE CODE	①	②	③ ④ ⑤ ⑥	⑦	
L. 15	P. 22	<b>12001019</b>	163,00	200,00	248,00	364,00
	P. 35	<b>12001020</b>	188,00	237,00	300,00	466,00
	P. 46	<b>12001021</b>	221,00	281,00	365,00	592,00
	P. 51	<b>12001022</b>	221,00	281,00	365,00	592,00
	P. 62	<b>12001069</b>	247,00	315,00	412,00	682,00
	L. 20	P. 22	<b>12001023</b>	163,00	200,00	248,00
P. 35		<b>12001024</b>	188,00	237,00	300,00	466,00
P. 46		<b>12001025</b>	221,00	281,00	365,00	592,00
P. 51		<b>12001026</b>	221,00	281,00	365,00	592,00
P. 62		<b>12001070</b>	247,00	315,00	412,00	682,00
L. 25		P. 22	<b>12001027</b>	163,00	200,00	248,00
	P. 35	<b>12001028</b>	188,00	237,00	300,00	466,00
	P. 46	<b>12001029</b>	221,00	281,00	365,00	592,00
	P. 51	<b>12001030</b>	221,00	281,00	365,00	592,00
	P. 62	<b>12001071</b>	247,00	315,00	412,00	682,00
	L. 30	P. 22	<b>12001031</b>	176,00	223,00	278,00
P. 35		<b>12001032</b>	205,00	264,00	333,00	517,00
P. 46		<b>12001033</b>	240,00	310,00	401,00	646,00
P. 51		<b>12001034</b>	240,00	310,00	401,00	646,00
P. 62		<b>12001072</b>	276,00	355,00	459,00	747,00
L. 35		P. 22	<b>12001035</b>	176,00	223,00	278,00
	P. 35	<b>12001036</b>	205,00	264,00	333,00	517,00
	P. 46	<b>12001037</b>	240,00	310,00	401,00	646,00
	P. 51	<b>12001038</b>	240,00	310,00	401,00	646,00
	P. 62	<b>12001073</b>	276,00	355,00	459,00	747,00
	L. 50	P. 22	<b>12001039</b>	194,00	259,00	325,00
P. 35		<b>12001040</b>	227,00	302,00	382,00	592,00
P. 46		<b>12001041</b>	271,00	359,00	459,00	729,00
P. 51		<b>12001042</b>	271,00	359,00	459,00	729,00
P. 62		<b>12001074</b>	299,00	396,00	510,00	824,00

## AIRY SISTEMA | BASI SOSPESE H. 50

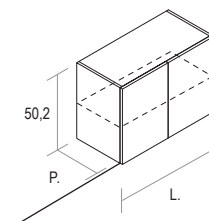
AIRY SISTEMA  
WALL HUNG BASES H.50BASE 2 ANTE  
BASE W/2 DOORS

DIMENSIONI DIMENSIONS	CODICE CODE	①	②	③ ④ ⑤ ⑥	⑦	
L. 50	P. 22	<b>12006001</b>	217,00	280,00	348,00	505,00
	P. 35	<b>12006002</b>	251,00	324,00	407,00	615,00
	P. 46	<b>12006003</b>	295,00	380,00	484,00	752,00
	P. 51	<b>12006004</b>	295,00	380,00	484,00	752,00
	P. 62	<b>12006025</b>	329,00	422,00	538,00	850,00
	L. 60	P. 22	<b>12006005</b>	231,00	304,00	379,00
P. 35		<b>12006006</b>	271,00	355,00	446,00	671,00
P. 46		<b>12006007</b>	311,00	408,00	519,00	805,00
P. 51		<b>12006008</b>	311,00	408,00	519,00	805,00
P. 62		<b>12006026</b>	346,00	451,00	576,00	904,00
L. 70		P. 22	<b>12006009</b>	244,00	330,00	411,00
	P. 35	<b>12006010</b>	286,00	380,00	478,00	719,00
	P. 46	<b>12006011</b>	340,00	446,00	564,00	867,00
	P. 51	<b>12006012</b>	340,00	446,00	564,00	867,00
	P. 62	<b>12006027</b>	374,00	490,00	621,00	967,00
	L. 85	P. 22	<b>12006013</b>	272,00	373,00	467,00
P. 35		<b>12006014</b>	310,00	422,00	530,00	796,00
P. 46		<b>12006015</b>	366,00	490,00	619,00	945,00
P. 51		<b>12006016</b>	366,00	490,00	619,00	945,00
P. 62		<b>12006028</b>	407,00	538,00	681,00	1.053,00
L. 95		P. 22	<b>12006029</b>	287,00	400,00	500,00
	P. 35	<b>12006030</b>	327,00	450,00	565,00	849,00
	P. 46	<b>12006031</b>	386,00	521,00	657,00	1.002,00
	P. 51	<b>12006032</b>	386,00	521,00	657,00	1.002,00
	P. 62	<b>12006033</b>	429,00	571,00	721,00	1.109,00
	L. 100	P. 22	<b>12006017</b>	292,00	407,00	512,00
P. 35		<b>12006018</b>	336,00	464,00	584,00	876,00
P. 46		<b>12006019</b>	401,00	540,00	681,00	1.035,00
P. 51		<b>12006020</b>	401,00	540,00	681,00	1.035,00
P. 62		<b>12006034</b>	446,00	595,00	748,00	1.146,00
L. 105		P. 22	<b>12006035</b>	294,00	417,00	524,00
	P. 35	<b>12006036</b>	344,00	478,00	601,00	903,00
	P. 46	<b>12006037</b>	411,00	557,00	699,00	1.063,00
	P. 51	<b>12006038</b>	411,00	557,00	699,00	1.063,00
	P. 62	<b>12006039</b>	458,00	612,00	769,00	1.176,00

## FINITURE/FINISHES:

① NOBILITATO; ② LACCATO OPACO; ③ LACCATO LUCIDO; ④ LACCATO METALLO; ⑤ IMPIALLACCIATO; ⑥ HPL; ⑦ RESINA CEMENTO  
① MELAMINE; ② MATT LACQUERED; ③ GLOSSY LACQUERED; ④ METAL LACQUERED; ⑤ VENEREED WOOD; ⑥ HPL; ⑦ RESIN CEMENT

## FINITURE/FINISHES:

① NOBILITATO; ② LACCATO OPACO; ③ LACCATO LUCIDO; ④ LACCATO METALLO; ⑤ IMPIALLACCIATO; ⑥ HPL; ⑦ RESINA CEMENTO  
① MELAMINE; ② MATT LACQUERED; ③ GLOSSY LACQUERED; ④ METAL LACQUERED; ⑤ VENEREED WOOD; ⑥ HPL; ⑦ RESIN CEMENT

**AIRY SISTEMA | BASI SOSPENSE H. 50**

AIRY SISTEMA  
WALL HUNG BASES H.50

**BASE 1 ANTA RIBALTA CON CESTO PORTABIANCHERIA**  
FLIP-DOWN DOOR BASE W/LAUNDRY BASKET

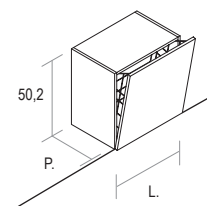

**DIM. CESTO PORTABIANCHERIA H. 43 L. 27/40 P. 28**  
LAUNDRY BASKET DIM.  
H. 43 W. 27/40 D. 28

**! ATTENZIONE NON UTILIZZABILE CON GOLA G3**  
!ATTENTION DO NOT USE WITH G3 GROOVE

DIMENSIONI DIMENSIONS	CODICE CODE	①	②	③ ④ ⑤ ⑥	⑦	
L. 35	P. 35	<b>12804001</b>	275,00	333,00	404,00	590,00
	P. 46	<b>12804002</b>	310,00	381,00	472,00	719,00
	P. 51	<b>12804003</b>	310,00	381,00	472,00	719,00
L. 50	P. 62	<b>12804010</b>	337,00	417,00	521,00	811,00
	P. 35	<b>12804004</b>	322,00	397,00	478,00	691,00
	P. 46	<b>12804005</b>	363,00	450,00	551,00	823,00
	P. 51	<b>12804006</b>	363,00	450,00	551,00	823,00
	P. 62	<b>12804007</b>	387,00	483,00	598,00	914,00

**AIRY SISTEMA | BASI SOSPENSE H. 50**

AIRY SISTEMA  
WALL HUNG BASES H.50

**BASE A GIORNO**  
OPEN BASE

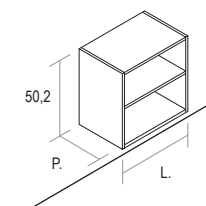

DIMENSIONI DIMENSIONS	CODICE CODE	①	②	③ ④ ⑤ ⑥	⑦	
L. 25	P. 35	<b>13017041</b>	201,00	374,00	446,00	-
	P. 46	<b>13017042</b>	243,00	478,00	577,00	-
	P. 51	<b>13017043</b>	243,00	478,00	577,00	-
L. 35	P. 62	<b>13017044</b>	255,00	526,00	632,00	-
	P. 35	<b>13017045</b>	207,00	390,00	466,00	-
	P. 46	<b>13017046</b>	251,00	508,00	612,00	-
L. 50	P. 51	<b>13017047</b>	251,00	508,00	612,00	-
	P. 62	<b>13017048</b>	282,00	594,00	717,00	-
	P. 35	<b>13017049</b>	242,00	461,00	555,00	-
	P. 46	<b>13017050</b>	295,00	603,00	730,00	-
	P. 51	<b>13017051</b>	295,00	603,00	730,00	-
L. 25	P. 62	<b>13017052</b>	332,00	704,00	854,00	-
	P. 35 - 46	<b>13417030</b>	316,00	574,00	693,00	-
	P. 35 - 51	<b>13417031</b>	316,00	574,00	693,00	-
L. 35	P. 35 - 46	<b>13417032</b>	327,00	610,00	735,00	-
	P. 35 - 51	<b>13417033</b>	327,00	610,00	735,00	-
L. 50	P. 35 - 46	<b>13417034</b>	384,00	724,00	876,00	-
	P. 35 - 51	<b>13417035</b>	384,00	724,00	876,00	-
L. 15	P. 35	<b>12717004</b>	127,00	206,00	259,00	376,00*
	P. 46	<b>12717005</b>	158,00	265,00	333,00	490,00*
	P. 51	<b>12717006</b>	158,00	265,00	333,00	490,00*
	P. 62	<b>12717008</b>	178,00	299,00	379,00	562,00*

**BASE A GIORNO PER CAMBIO DI PROFONDITÀ DX-SX**  
DEPTH-CHANGING OPEN BASE

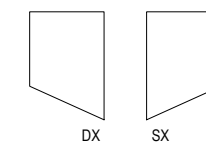
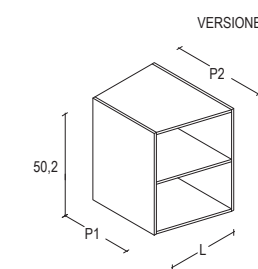

**BASE TERMINALE A GIORNO DX-SX**  
OPEN SIDE-BASE

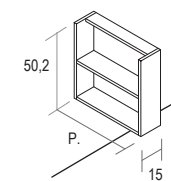

\*LA VARIANTE IN FINITURA RESINA CEMENTO E' DISPONIBILE SOLO PER IL FRONTALE, MENTRE LA PARTE A GIORNO INTERNA SARA' REALIZZATA IN UN'ALTRA FINITURA DA SPECIFICARE IN FASE D'ORDINE.

\*THE CEMENT RESIN FINISH IS AVAILABLE FOR FRONTS ONLY. THE FINISH OF THE SIDE-OPEN COMPARTMENT MUST BE SPECIFIED IN THE ORDER.

**FINITURE/FINISHES:**

① NOBILITATO; ② LACCATO OPACO; ③ LACCATO LUCIDO; ④ LACCATO METALLO; ⑤ IMPIALLACCIATO; ⑥ HPL; ⑦ RESINA CEMENTO  
① MELAMINE; ② MATT LACQUERED; ③ GLOSSY LACQUERED; ④ METAL LACQUERED; ⑤ VENEREED WOOD; ⑥ HPL; ⑦ RESIN CEMENT

**FINITURE/FINISHES:**

① NOBILITATO; ② LACCATO OPACO; ③ LACCATO LUCIDO; ④ LACCATO METALLO; ⑤ IMPIALLACCIATO; ⑥ HPL; ⑦ RESINA CEMENTO  
① MELAMINE; ② MATT LACQUERED; ③ GLOSSY LACQUERED; ④ METAL LACQUERED; ⑤ VENEREED WOOD; ⑥ HPL; ⑦ RESIN CEMENT

**AIRY SISTEMA**  
**BASI SOSPESA H. 60**



*AIRY SISTEMA*

*WALL HUNG BASES H. 60*

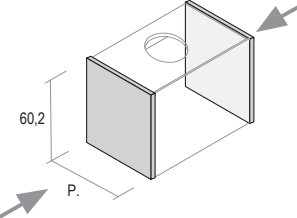
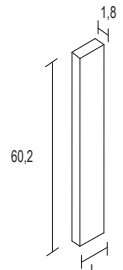
**AIRY SISTEMA | ACCESSORI PER BASI H. 60 - OPZIONALI**

AIRY SISTEMA ACCESSORIES FOR BASES H. 60		DIMENSIONI DIMENSIONS	CODICE CODE	①	②	③ ④ ⑤ ⑥	⑦	
<b>FIANCO DI FINITURA SP. 1,2</b> ADDITIONAL FINISHING SIDE-PANEL TH. 1.2  	P. 35	H. 60	<b>19000017</b>	95,00	141,00	157,00	324,00	
	P. 46		<b>19000020</b>	117,00	173,00	201,00	417,00	
	P. 51		<b>19000021</b>	117,00	173,00	201,00	417,00	
	P. 62		<b>19000025</b>	120,00	182,00	233,00	538,00	
<b>N.B. I PREZZI SI RIFERISCONO AD UN SINGOLO FIANCO</b> N.B. : THE PRICES REFER TO A SINGLE SIDE-PANEL								
<b>FASCIA DI TAMPONAMENTO PER BASE H. 60</b> FILLER WOODEN-STRIP FOR BASES H.60  		H. 60	L. 5 - 15	<b>19126008</b>	85,00	127,00	139,00	223,00
<b>N.B. MISURA MINIMA L. 5 CM E MASSIMA L. 15 CM</b> N.B. MIN. L. 5 CM AND MAX L. 15 CM								

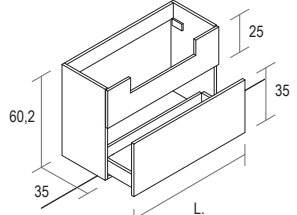
**AIRY SISTEMA | BASI SOSPESSE H. 60**

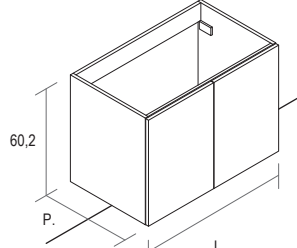
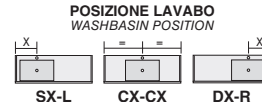
AIRY SISTEMA WALL HUNG BASES H. 60		DIMENSIONI DIMENSIONS	CODICE CODE	①	②	③ ④ ⑤ ⑥	⑦	
<b>BASE LAVABO FRONTALE FISSO + 1 CASSETTO (25 SUP.+35 INF.)</b> WASHBASIN BASE W/1 FIXED FRONT + 1 DRAWER  		L. 70	P. 35	<b>12614005</b>	409,00	527,00	644,00	938,00
<b>ILLUMINAZIONE INTERNA DISPONIBILE</b> INTERNAL LIGHTING AVAILABLE  POSIZIONE LAVABO WASHBASIN POSITION 		L. 85	P. 35	<b>12614006</b>	439,00	576,00	706,00	1.031,00
		L. 95	P. 35	<b>12614007</b>	459,00	610,00	748,00	1.094,00
<b>BASE LAVABO 2 ANTE</b> WASHBASIN BASE W/2 DOORS  		L. 60	P. 35	<b>12106080</b>	291,00	393,00	501,00	773,00
		P. 46	<b>12106025</b>	336,00	453,00	584,00	930,00	
<b>POSIZIONE LAVABO</b> WASHBASIN POSITION 		P. 51	<b>12106026</b>	336,00	453,00	584,00	930,00	
		P. 62	<b>12106027</b>	363,00	493,00	639,00	1.036,00	
		L. 70	P. 35	<b>12106081</b>	296,00	411,00	527,00	819,00
		P. 46	<b>12106028</b>	353,00	485,00	624,00	989,00	
		P. 51	<b>12106029</b>	353,00	485,00	624,00	989,00	
		P. 62	<b>12106030</b>	381,00	524,00	681,00	1.098,00	
		L. 85	P. 35	<b>12106082</b>	338,00	474,00	605,00	927,00
		P. 46	<b>12106031</b>	398,00	550,00	703,00	1.100,00	
		P. 51	<b>12106032</b>	398,00	550,00	703,00	1.100,00	
		P. 62	<b>12106033</b>	422,00	584,00	753,00	1.201,00	
		L. 95	P. 35	<b>12106083</b>	356,00	507,00	646,00	987,00
		P. 46	<b>12106034</b>	419,00	586,00	746,00	1.163,00	
		P. 51	<b>12106035</b>	419,00	586,00	746,00	1.163,00	
		P. 62	<b>12106036</b>	442,00	620,00	796,00	1.266,00	
		L. 100	P. 35	<b>12106084</b>	360,00	518,00	662,00	1.013,00
		P. 46	<b>12106037</b>	429,00	601,00	768,00	1.195,00	
		P. 51	<b>12106038</b>	429,00	601,00	768,00	1.195,00	
		P. 62	<b>12106039</b>	467,00	650,00	833,00	1.313,00	
		L. 105	P. 35	<b>12106085</b>	370,00	534,00	682,00	1.043,00
		P. 46	<b>12106040</b>	439,00	619,00	789,00	1.227,00	
		P. 51	<b>12106041</b>	439,00	619,00	789,00	1.227,00	
		P. 62	<b>12106042</b>	478,00	668,00	854,00	1.346,00	

**FINITURE/FINISHES:**  
 ① NOBILITATO; ② LACCATO OPACO; ③ LACCATO LUCIDO; ④ LACCATO METALLO; ⑤ IMPIALLACCIATO; ⑥ HPL; ⑦ RESINA CEMENTO  
 ① MELAMINE; ② MATT LACQUERED; ③ GLOSSY LACQUERED; ④ METAL LACQUERED; ⑤ VENEREED WOOD; ⑥ HPL; ⑦ RESIN CEMENT

**FINITURE/FINISHES:**  
 ① NOBILITATO; ② LACCATO OPACO; ③ LACCATO LUCIDO; ④ LACCATO METALLO; ⑤ IMPIALLACCIATO; ⑥ HPL; ⑦ RESINA CEMENTO  
 ① MELAMINE; ② MATT LACQUERED; ③ GLOSSY LACQUERED; ④ METAL LACQUERED; ⑤ VENEREED WOOD; ⑥ HPL; ⑦ RESIN CEMENT

## AIRY SISTEMA | BASI SOSPESSE H. 60 (25 SUP. + 35 INF.)

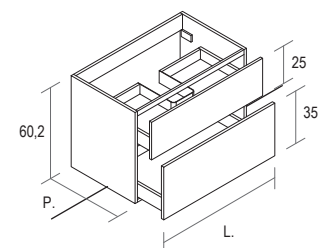
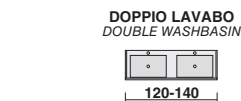
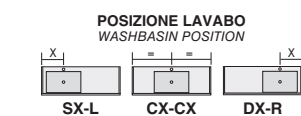
AIRY SISTEMA  
WALL HUNG BASES H. 60BASE LAVABO 2 CASSETTI  
WASHBASIN BASE W/2 DRAWERS
 ILLUMINAZIONE INTERNA  
DISPONIBILE  
INTERNAL LIGHTING AVAILABLE

DIMENSIONI DIMENSIONS	CODICE CODE	①	②	③ ④ ⑤ ⑥	⑦	
L. 60	P. 35	<b>12134001</b>	566,00	671,00	778,00	1.058,00
	P. 46	<b>12134002</b>	624,00	742,00	873,00	1.228,00
	P. 51	<b>12134003</b>	624,00	742,00	873,00	1.228,00
	P. 62	<b>12134004</b>	657,00	785,00	933,00	1.340,00
L. 70	P. 35	<b>12134005</b>	589,00	706,00	822,00	1.123,00
	P. 46	<b>12134006</b>	650,00	781,00	921,00	1.297,00
	P. 51	<b>12134007</b>	650,00	781,00	921,00	1.297,00
L. 85	P. 62	<b>12134008</b>	680,00	822,00	978,00	1.406,00
	P. 35	<b>12134009</b>	644,00	780,00	910,00	1.242,00
	P. 46	<b>12134010</b>	710,00	862,00	1.014,00	1.422,00
L. 95	P. 51	<b>12134011</b>	710,00	862,00	1.014,00	1.422,00
	P. 62	<b>12134012</b>	746,00	909,00	1.078,00	1.537,00
	P. 35	<b>12134013</b>	669,00	819,00	959,00	1.311,00
L. 105	P. 46	<b>12134014</b>	743,00	909,00	1.070,00	1.496,00
	P. 51	<b>12134015</b>	743,00	909,00	1.070,00	1.496,00
	P. 62	<b>12134016</b>	778,00	953,00	1.131,00	1.611,00
L. 120	P. 35	<b>12134017</b>	695,00	857,00	1.005,00	1.380,00
	P. 46	<b>12134018</b>	769,00	948,00	1.119,00	1.567,00
	P. 51	<b>12134019</b>	769,00	948,00	1.119,00	1.567,00
L. 140	P. 62	<b>12134020</b>	808,00	998,00	1.184,00	1.685,00
	P. 35	<b>12134021</b>	730,00	915,00	1.075,00	1.479,00
	P. 46	<b>12134022</b>	811,00	1.009,00	1.193,00	1.672,00
L. 105	P. 51	<b>12134023</b>	811,00	1.009,00	1.193,00	1.672,00
	P. 62	<b>12134024</b>	835,00	1.045,00	1.245,00	1.775,00
	P. 35	<b>12134025</b>	783,00	994,00	1.172,00	1.617,00
L. 120	P. 46	<b>12134026</b>	871,00	1.096,00	1.297,00	1.819,00
	P. 51	<b>12134027</b>	871,00	1.096,00	1.297,00	1.819,00
	P. 62	<b>12134028</b>	914,00	1.151,00	1.368,00	1.942,00

## FINITURE/FINISHES:

 ① NOBILITATO; ② LACCATO OPACO; ③ LACCATO LUCIDO; ④ LACCATO METALLO; ⑤ IMPIALLACCIATO; ⑥ HPL; ⑦ RESINA CEMENTO  
 ① MELAMINE; ② MATT LACQUERED; ③ GLOSSY LACQUERED; ④ METAL LACQUERED; ⑤ VENEREED WOOD; ⑥ HPL; ⑦ RESIN CEMENT

## AIRY SISTEMA | BASI SOSPESSE H. 60 (35 SUP. + 25 INF.)

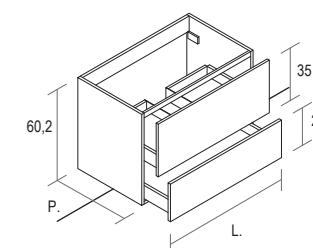
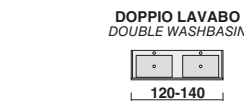
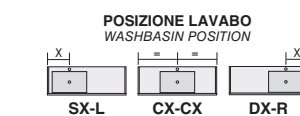
AIRY SISTEMA  
WALL HUNG BASES H. 60BASE LAVABO 2 CASSETTI  
WASHBASIN BASE W/2 DRAWERS
 ILLUMINAZIONE INTERNA  
DISPONIBILE  
INTERNAL LIGHTING AVAILABLE

DIMENSIONI DIMENSIONS	CODICE CODE	①	②	③ ④ ⑤ ⑥	⑦	
L. 60	P. 35	<b>12134030</b>	566,00	671,00	778,00	1.058,00
	P. 46	<b>12134031</b>	624,00	742,00	873,00	1.228,00
	P. 51	<b>12134032</b>	624,00	742,00	873,00	1.228,00
	P. 62	<b>12134033</b>	657,00	785,00	933,00	1.340,00
L. 70	P. 35	<b>12134034</b>	589,00	706,00	822,00	1.123,00
	P. 46	<b>12134035</b>	650,00	781,00	921,00	1.297,00
	P. 51	<b>12134036</b>	650,00	781,00	921,00	1.297,00
L. 85	P. 62	<b>12134037</b>	680,00	822,00	978,00	1.406,00
	P. 35	<b>12134038</b>	644,00	780,00	910,00	1.242,00
	P. 46	<b>12134039</b>	710,00	862,00	1.014,00	1.422,00
L. 95	P. 51	<b>12134040</b>	710,00	862,00	1.014,00	1.422,00
	P. 62	<b>12134041</b>	746,00	909,00	1.078,00	1.537,00
	P. 35	<b>12134042</b>	669,00	819,00	959,00	1.311,00
L. 105	P. 46	<b>12134043</b>	743,00	909,00	1.070,00	1.496,00
	P. 51	<b>12134044</b>	743,00	909,00	1.070,00	1.496,00
	P. 62	<b>12134045</b>	778,00	953,00	1.131,00	1.611,00
L. 120	P. 35	<b>12134046</b>	695,00	857,00	1.005,00	1.380,00
	P. 46	<b>12134047</b>	769,00	948,00	1.119,00	1.567,00
	P. 51	<b>12134048</b>	769,00	948,00	1.119,00	1.567,00
L. 140	P. 62	<b>12134049</b>	808,00	998,00	1.184,00	1.685,00
	P. 35	<b>12134050</b>	730,00	915,00	1.075,00	1.479,00
	P. 46	<b>12134051</b>	811,00	1.009,00	1.193,00	1.672,00
L. 105	P. 51	<b>12134052</b>	811,00	1.009,00	1.193,00	1.672,00
	P. 62	<b>12134053</b>	835,00	1.045,00	1.245,00	1.775,00
	P. 35	<b>12134054</b>	783,00	994,00	1.172,00	1.617,00
L. 120	P. 46	<b>12134055</b>	871,00	1.096,00	1.297,00	1.819,00
	P. 51	<b>12134056</b>	871,00	1.096,00	1.297,00	1.819,00
	P. 62	<b>12134057</b>	914,00	1.151,00	1.368,00	1.942,00

## FINITURE/FINISHES:

 ① NOBILITATO; ② LACCATO OPACO; ③ LACCATO LUCIDO; ④ LACCATO METALLO; ⑤ IMPIALLACCIATO; ⑥ HPL; ⑦ RESINA CEMENTO  
 ① MELAMINE; ② MATT LACQUERED; ③ GLOSSY LACQUERED; ④ METAL LACQUERED; ⑤ VENEREED WOOD; ⑥ HPL; ⑦ RESIN CEMENT

## AIRY SISTEMA | BASI SOSPESSE H. 60

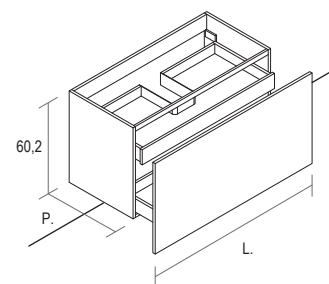
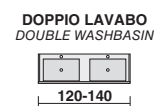
AIRY SISTEMA  
WALL HUNG BASES H. 60BASE LAVABO 1 CASSETTONE  
+ 1 CASSETTO INTERNO H. 10  
BASE W/1 DRAWER  
+ 1 INTERNAL DRAWER H. 10
 ILLUMINAZIONE INTERNA  
DISPONIBILE  
INTERNAL LIGHTING AVAILABLE

DIMENSIONI DIMENSIONS	CODICE CODE	①	②	③ ④ ⑤ ⑥	⑦	
L. 60	P. 35	<b>12125061</b>	608,00	713,00	818,00	1.103,00
	P. 46	<b>12125062</b>	663,00	785,00	914,00	1.271,00
	P. 51	<b>12125063</b>	663,00	785,00	914,00	1.271,00
	P. 62	<b>12125064</b>	695,00	827,00	972,00	1.384,00
L. 70	P. 35	<b>12125065</b>	633,00	754,00	868,00	1.173,00
	P. 46	<b>12125066</b>	696,00	832,00	967,00	1.348,00
	P. 51	<b>12125067</b>	696,00	832,00	967,00	1.348,00
	P. 62	<b>12125068</b>	725,00	872,00	1.025,00	1.457,00
L. 85	P. 35	<b>12125069</b>	697,00	839,00	965,00	1.303,00
	P. 46	<b>12125070</b>	764,00	921,00	1.070,00	1.483,00
	P. 51	<b>12125071</b>	764,00	921,00	1.070,00	1.483,00
	P. 62	<b>12125072</b>	801,00	967,00	1.133,00	1.599,00
L. 95	P. 35	<b>12125073</b>	730,00	884,00	1.019,00	1.380,00
	P. 46	<b>12125074</b>	805,00	974,00	1.131,00	1.567,00
	P. 51	<b>12125075</b>	805,00	974,00	1.131,00	1.567,00
	P. 62	<b>12125076</b>	839,00	1.019,00	1.194,00	1.680,00
L. 105	P. 35	<b>12125078</b>	761,00	931,00	1.073,00	1.455,00
	P. 46	<b>12125079</b>	827,00	1.012,00	1.177,00	1.633,00
	P. 51	<b>12125080</b>	827,00	1.012,00	1.177,00	1.633,00
	P. 62	<b>12125081</b>	866,00	1.062,00	1.244,00	1.751,00
L. 120	P. 35	<b>12125082</b>	807,00	997,00	1.152,00	1.566,00
	P. 46	<b>12125083</b>	887,00	1.092,00	1.270,00	1.759,00
	P. 51	<b>12125084</b>	887,00	1.092,00	1.270,00	1.759,00
	P. 62	<b>12125085</b>	910,00	1.127,00	1.321,00	1.861,00
L. 140	P. 35	<b>12125086</b>	872,00	1.089,00	1.261,00	1.717,00
	P. 46	<b>12125087</b>	950,00	1.184,00	1.379,00	1.909,00
	P. 51	<b>12125088</b>	950,00	1.184,00	1.379,00	1.909,00
	P. 62	<b>12125089</b>	1.003,00	1.247,00	1.458,00	2.042,00

## FINITURE/FINISHES:

 ① NOBILITATO; ② LACCATO OPACO; ③ LACCATO LUCIDO; ④ LACCATO METALLO; ⑤ IMPIALLACCIATO; ⑥ HPL; ⑦ RESINA CEMENTO  
 ① MELAMINE; ② MATT LACQUERED; ③ GLOSSY LACQUERED; ④ METAL LACQUERED; ⑤ VENEREED WOOD; ⑥ HPL; ⑦ RESIN CEMENT

## AIRY SISTEMA | BASI SOSPESSE H. 60

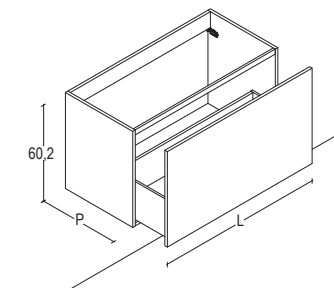
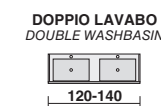
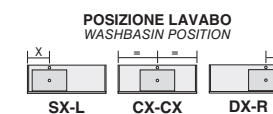
AIRY SISTEMA  
WALL HUNG BASES H. 60BASE LAVABO 1 CASSETTONE  
WASHBASIN BASE W/1 DRAWER
 ILLUMINAZIONE INTERNA  
DISPONIBILE  
INTERNAL LIGHTING AVAILABLE

DIMENSIONI DIMENSIONS	CODICE CODE	①	②	③ ④ ⑤ ⑥	⑦	
L. 60	P. 35	<b>12108140</b>	481,00	577,00	681,00	962,00
	P. 46	<b>12108141</b>	527,00	645,00	772,00	1.127,00
	P. 51	<b>12108142</b>	527,00	645,00	772,00	1.127,00
	P. 62	<b>12108143</b>	559,00	687,00	830,00	1.240,00
L. 70	P. 35	<b>12108144</b>	494,00	607,00	720,00	1.022,00
	P. 46	<b>12108145</b>	547,00	680,00	814,00	1.190,00
	P. 51	<b>12108146</b>	547,00	680,00	814,00	1.190,00
	P. 62	<b>12108147</b>	576,00	720,00	872,00	1.299,00
L. 85	P. 35	<b>12108148</b>	542,00	678,00	802,00	1.135,00
	P. 46	<b>12108149</b>	597,00	752,00	900,00	1.308,00
	P. 51	<b>12108150</b>	597,00	752,00	900,00	1.308,00
	P. 62	<b>12108151</b>	634,00	798,00	963,00	1.424,00
L. 95	P. 35	<b>12108152</b>	564,00	713,00	846,00	1.202,00
	P. 46	<b>12108153</b>	626,00	793,00	950,00	1.380,00
	P. 51	<b>12108154</b>	626,00	793,00	950,00	1.380,00
	P. 62	<b>12108155</b>	660,00	838,00	1.013,00	1.493,00
L. 105	P. 35	<b>12108156</b>	583,00	749,00	889,00	1.267,00
	P. 46	<b>12108157</b>	635,00	819,00	985,00	1.432,00
	P. 51	<b>12108158</b>	635,00	819,00	985,00	1.432,00
	P. 62	<b>12108159</b>	632,00	825,00	1.007,00	1.505,00
L. 120	P. 35	<b>12108160</b>	619,00	799,00	953,00	1.361,00
	P. 46	<b>12108161</b>	685,00	882,00	1.059,00	1.542,00
	P. 51	<b>12108162</b>	685,00	882,00	1.059,00	1.542,00
	P. 62	<b>12108163</b>	708,00	917,00	1.110,00	1.644,00
L. 140	P. 35	<b>12108164</b>	659,00	869,00	1.040,00	1.490,00
	P. 46	<b>12108165</b>	719,00	951,00	1.146,00	1.667,00
	P. 51	<b>12108166</b>	719,00	951,00	1.146,00	1.667,00
	P. 62	<b>12108167</b>	772,00	1.014,00	1.225,00	1.800,00

## FINITURE/FINISHES:

 ① NOBILITATO; ② LACCATO OPACO; ③ LACCATO LUCIDO; ④ LACCATO METALLO; ⑤ IMPIALLACCIATO; ⑥ HPL; ⑦ RESINA CEMENTO  
 ① MELAMINE; ② MATT LACQUERED; ③ GLOSSY LACQUERED; ④ METAL LACQUERED; ⑤ VENEREED WOOD; ⑥ HPL; ⑦ RESIN CEMENT



## AIRY SISTEMA | BASI SOSPESE H. 60 (25 SUP. + 35 INF.)

AIRY SISTEMA WALL HUNG BASES H. 60	DIMENSIONI DIMENSIONS	CODICE CODE	①	②	③ ④ ⑤ ⑥	⑦
<b>BASE LAVABO 2 CASSETTI E VANO A GIORNO LATERALE DX-SX L. 15</b> WASHBASIN BASE W/2 DRAWERS AND ONE-SIDE SHELVES (R / L VERSION)	P. 35	12135001D	759,00	948,00	1.109,00	1.477,00
		12135001S	759,00	948,00	1.109,00	1.477,00
	P. 46	12135002D	863,00	1.108,00	1.318,00	1.795,00
		12135002S	863,00	1.108,00	1.318,00	1.795,00
	L. 120	12135003D	863,00	1.108,00	1.318,00	1.795,00
		12135003S	863,00	1.108,00	1.318,00	1.795,00
	P. 51	12135004D	911,00	1.174,00	1.407,00	1.931,00
		12135004S	911,00	1.174,00	1.407,00	1.931,00
	P. 62	12135005D	911,00	1.174,00	1.407,00	1.931,00
		12135005S	911,00	1.174,00	1.407,00	1.931,00

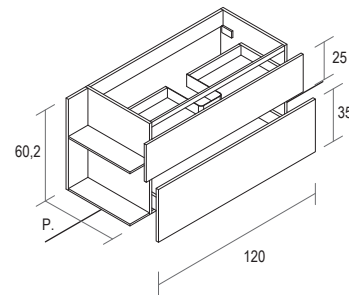

**ILLUMINAZIONE INTERNA DISPONIBILE**  
INTERNAL LIGHTING AVAILABLE

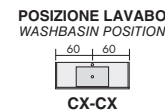

**! ATTENZIONE NON UTILIZZABILE CON:**  
- CONSOLLE IN CERAMICA  
- GOLA G3  
!ATTENTION DO NOT USE:  
- CERAMIC CONSOLE  
- G3 GROOVE

## AIRY SISTEMA | BASI SOSPESE H. 60 (35 SUP. + 25 INF.)

AIRY SISTEMA WALL HUNG BASES H. 60	DIMENSIONI DIMENSIONS	CODICE CODE	①	②	③ ④ ⑤ ⑥	⑦
<b>BASE LAVABO 2 CASSETTI E VANO A GIORNO LATERALE DX-SX L. 15</b> WASHBASIN BASE W/2 DRAWERS AND ONE-SIDE SHELVES (R / L VERSION)	P. 35	12135005D	759,00	948,00	1.109,00	1.477,00
		12135005S	759,00	948,00	1.109,00	1.477,00
	P. 46	12135006D	863,00	1.108,00	1.318,00	1.795,00
		12135006S	863,00	1.108,00	1.318,00	1.795,00
	L. 120	12135007D	863,00	1.108,00	1.318,00	1.795,00
		12135007S	863,00	1.108,00	1.318,00	1.795,00
	P. 51	12135008D	911,00	1.174,00	1.407,00	1.931,00
		12135008S	911,00	1.174,00	1.407,00	1.931,00
	P. 62	12135009D	911,00	1.174,00	1.407,00	1.931,00
		12135009S	911,00	1.174,00	1.407,00	1.931,00

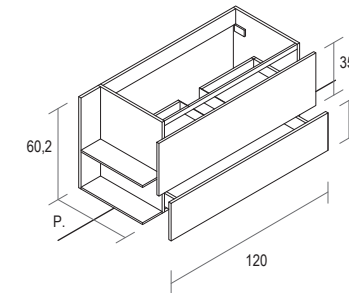

**ILLUMINAZIONE INTERNA DISPONIBILE**  
INTERNAL LIGHTING AVAILABLE

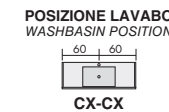

**! ATTENZIONE NON UTILIZZABILE CON:**  
- CONSOLLE IN CERAMICA  
- GOLA G3  
!ATTENTION DO NOT USE:  
- CERAMIC CONSOLE  
- G3 GROOVE

\* VANO A GIORNO LATERALE NON DISPONIBILE NELLA FINITURA RESINA CEMENTO.  
SPECIFICARE IN FASE D'ORDINE LA FINITURA SCELTA.

\* SIDE OPEN COMPARTMENT NOT AVAILABLE IN CEMENT RESIN FINISH. SPECIFY THE CHOSEN FINISH IN THE ORDER.

\* VANO A GIORNO LATERALE NON DISPONIBILE NELLA FINITURA RESINA CEMENTO.  
SPECIFICARE IN FASE D'ORDINE LA FINITURA SCELTA.

\* SIDE OPEN COMPARTMENT NOT AVAILABLE IN CEMENT RESIN FINISH. SPECIFY THE CHOSEN FINISH IN THE ORDER.

## FINITURE/FINISHES:

① NOBILITATO; ② LACCATO OPACO; ③ LACCATO LUCIDO; ④ LACCATO METALLO; ⑤ IMPIALLACCIATO; ⑥ HPL; ⑦ RESINA CEMENTO  
① MELAMINE; ② MATT LACQUERED; ③ GLOSSY LACQUERED; ④ METAL LACQUERED; ⑤ VENEREED WOOD; ⑥ HPL; ⑦ RESIN CEMENT

## FINITURE/FINISHES:

① NOBILITATO; ② LACCATO OPACO; ③ LACCATO LUCIDO; ④ LACCATO METALLO; ⑤ IMPIALLACCIATO; ⑥ HPL; ⑦ RESINA CEMENTO  
① MELAMINE; ② MATT LACQUERED; ③ GLOSSY LACQUERED; ④ METAL LACQUERED; ⑤ VENEREED WOOD; ⑥ HPL; ⑦ RESIN CEMENT

**AIRY SISTEMA | BASI SOSPESA H. 60**

AIRY SISTEMA WALL HUNG BASES H. 60		DIMENSIONI DIMENSIONS	CODICE CODE	①	②	③ ④ ⑤ ⑥	⑦
<b>BASE LAVABO 1 CASSETTONE + 1 CASSETTO INTERNO H. 10 E VANO A GIORNO LATERALE DX-SX L. 15</b> <i>1 DRAWER WASHBASIN BASE W/1 INTERNAL DRAWER H. 10 AND ONE-SIDE SHELVES (R/L VERSION)</i>	P. 35		<b>12137005D</b>	841,00	1.065,00	1.239,00	1.658,00
			<b>12137005S</b>	841,00	1.065,00	1.239,00	1.658,00
	P. 46		<b>12137006D</b>	920,00	1.171,00	1.376,00	1.861,00
			<b>12137006S</b>	920,00	1.171,00	1.376,00	1.861,00
	L. 120		<b>12137007D</b>	920,00	1.171,00	1.376,00	1.861,00
			<b>12137007S</b>	920,00	1.171,00	1.376,00	1.861,00
	P. 51		<b>12137008D</b>	958,00	1.227,00	1.452,00	1.986,00
			<b>12137008S</b>	958,00	1.227,00	1.452,00	1.986,00
	P. 62		<b>12137008D</b>	958,00	1.227,00	1.452,00	1.986,00
			<b>12137008S</b>	958,00	1.227,00	1.452,00	1.986,00

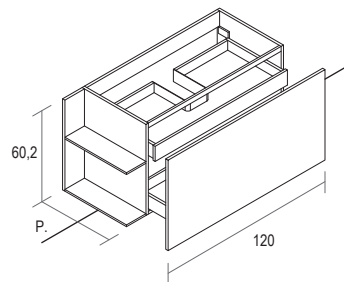

**ILLUMINAZIONE INTERNA DISPONIBILE**  
INTERNAL LIGHTING AVAILABLE



**! ATTENZIONE NON UTILIZZABILE CON:**  
- CONSOLE IN CERAMICA  
- GOLA G3  
*! ATTENTION DO NOT USE:*  
- CERAMIC CONSOLE  
- G3 GROOVE

\* VANO A GIORNO LATERALE NON DISPONIBILE NELLA FINITURA RESINA CEMENTO.  
SPECIFICARE IN FASE D'ORDINE LA FINITURA SCELTA.

\* SIDE OPEN COMPARTMENT NOT AVAILABLE IN CEMENT RESIN FINISH. SPECIFY THE CHOSEN FINISH IN THE ORDER.

**FINITURE/FINISHES:**  
① NOBILITATO; ② LACCATO OPACO; ③ LACCATO LUCIDO; ④ LACCATO METALLO; ⑤ IMPIALLACCIATO; ⑥ HPL; ⑦ RESINA CEMENTO  
① MELAMINE; ② MATT LACQUERED; ③ GLOSSY LACQUERED; ④ METAL LACQUERED; ⑤ VENEREED WOOD; ⑥ HPL; ⑦ RESIN CEMENT

**AIRY SISTEMA | BASI SOSPESA H. 60**

AIRY SISTEMA WALL HUNG BASES H. 60		DIMENSIONI DIMENSIONS	CODICE CODE	①	②	③ ④ ⑤ ⑥	⑦
<b>BASE 1 CASSETTONE + CASSETTO INTERNO H. 10</b> <i>BASE W/1 DRAWER + 1 INTERNAL DRAWER H. 10</i>	L. 25	P. 35	<b>12025086</b>	444,00	501,00	578,00	786,00
		P. 46	<b>12025087</b>	489,00	561,00	660,00	943,00
		P. 51	<b>12025088</b>	489,00	561,00	660,00	943,00
	P. 62	P. 62	<b>12025089</b>	516,00	599,00	715,00	1.048,00
		P. 35	<b>12025090</b>	472,00	544,00	628,00	857,00
		P. 46	<b>12025091</b>	522,00	609,00	717,00	1.019,00
	L. 35	P. 51	<b>12025092</b>	522,00	609,00	717,00	1.019,00
		P. 62	<b>12025093</b>	550,00	647,00	772,00	1.127,00
		P. 35	<b>12025094</b>	517,00	609,00	707,00	967,00
	L. 50	P. 46	<b>12025095</b>	561,00	669,00	789,00	1.125,00
		P. 51	<b>12025096</b>	561,00	669,00	789,00	1.125,00
		P. 62	<b>12025097</b>	593,00	712,00	848,00	1.234,00
	L. 60	P. 35	<b>12025098</b>	548,00	653,00	758,00	1.041,00
		P. 46	<b>12025099</b>	603,00	725,00	854,00	1.210,00
		P. 51	<b>12025100</b>	603,00	725,00	854,00	1.210,00
	P. 62	P. 62	<b>12025101</b>	635,00	768,00	912,00	1.321,00
		P. 35	<b>12025102</b>	573,00	695,00	808,00	1.112,00
		P. 46	<b>12025103</b>	636,00	772,00	909,00	1.287,00
	L. 70	P. 51	<b>12025104</b>	636,00	772,00	909,00	1.287,00
		P. 62	<b>12025105</b>	665,00	812,00	965,00	1.395,00
		P. 35	<b>12025106</b>	614,00	754,00	881,00	1.217,00
	L. 85	P. 46	<b>12025107</b>	697,00	854,00	1.003,00	1.414,00
		P. 51	<b>12025108</b>	697,00	854,00	1.003,00	1.414,00
		P. 62	<b>12025109</b>	715,00	883,00	1.048,00	1.511,00
	L. 95	P. 35	<b>12025110</b>	660,00	816,00	950,00	1.309,00
		P. 46	<b>12025111</b>	732,00	904,00	1.062,00	1.493,00
		P. 51	<b>12025112</b>	732,00	904,00	1.062,00	1.493,00
	P. 62	P. 62	<b>12025113</b>	770,00	950,00	1.125,00	1.610,00
		P. 35	<b>12025114</b>	679,00	848,00	991,00	1.369,00
		P. 46	<b>12025115</b>	757,00	941,00	1.107,00	1.560,00
	L. 105	P. 51	<b>12025116</b>	757,00	941,00	1.107,00	1.560,00
		P. 62	<b>12025117</b>	795,00	991,00	1.172,00	1.679,00
		P. 35	<b>12025118</b>	737,00	927,00	1.081,00	1.493,00
	L. 120	P. 46	<b>12025119</b>	817,00	1.023,00	1.200,00	1.686,00
		P. 51	<b>12025120</b>	817,00	1.023,00	1.200,00	1.686,00
		P. 62	<b>12025121</b>	857,00	1.074,00	1.269,00	1.807,00
	L. 140	P. 35	<b>12025122</b>	796,00	1.014,00	1.188,00	1.641,00
		P. 46	<b>12025123</b>	883,00	1.114,00	1.311,00	1.839,00
		P. 51	<b>12025124</b>	883,00	1.114,00	1.311,00	1.839,00
	P. 62	<b>12025125</b>	927,00	1.169,00	1.381,00	1.963,00	

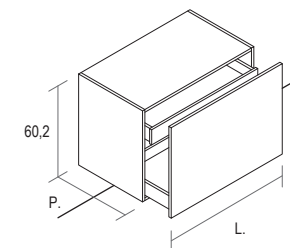

**ILLUMINAZIONE INTERNA DISPONIBILE**  
INTERNAL LIGHTING AVAILABLE

**FINITURE/FINISHES:**  
① NOBILITATO; ② LACCATO OPACO; ③ LACCATO LUCIDO; ④ LACCATO METALLO; ⑤ IMPIALLACCIATO; ⑥ HPL; ⑦ RESINA CEMENTO  
① MELAMINE; ② MATT LACQUERED; ③ GLOSSY LACQUERED; ④ METAL LACQUERED; ⑤ VENEREED WOOD; ⑥ HPL; ⑦ RESIN CEMENT

**AIRY SISTEMA | BASI SOSPESSE H. 60**

AIRY SISTEMA  
WALL HUNG BASES H. 60

**BASE 1 CASSETTONE**  
BASE W/1 DRAWER

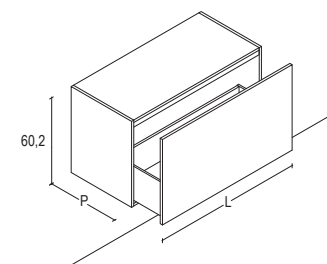

**ILLUMINAZIONE INTERNA DISPONIBILE**  
INTERNAL LIGHTING AVAILABLE

DIMENSIONI DIMENSIONS	CODICE CODE	①	②	③ ④ ⑤ ⑥	⑦	
L. 25	P. 35	<b>12008150</b>	347,00	402,00	478,00	684,00
	P. 46	<b>12008151</b>	390,00	464,00	562,00	843,00
	P. 51	<b>12008152</b>	390,00	464,00	562,00	843,00
	P. 62	<b>12008153</b>	419,00	502,00	618,00	947,00
L. 35	P. 35	<b>12008154</b>	362,00	432,00	518,00	743,00
	P. 46	<b>12008155</b>	408,00	497,00	606,00	901,00
	P. 51	<b>12008156</b>	408,00	497,00	606,00	901,00
	P. 62	<b>12008157</b>	438,00	533,00	658,00	1.009,00
L. 50	P. 35	<b>12008158</b>	391,00	483,00	582,00	837,00
	P. 46	<b>12008159</b>	432,00	538,00	659,00	991,00
	P. 51	<b>12008160</b>	432,00	538,00	659,00	991,00
	P. 62	<b>12008161</b>	463,00	582,00	718,00	1.100,00
L. 60	P. 35	<b>12008162</b>	412,00	516,00	621,00	900,00
	P. 46	<b>12008163</b>	462,00	584,00	712,00	1.065,00
	P. 51	<b>12008164</b>	462,00	584,00	712,00	1.065,00
	P. 62	<b>12008165</b>	493,00	627,00	770,00	1.177,00
L. 70	P. 35	<b>12008166</b>	427,00	550,00	662,00	961,00
	P. 46	<b>12008167</b>	483,00	619,00	756,00	1.129,00
	P. 51	<b>12008168</b>	483,00	619,00	756,00	1.129,00
	P. 62	<b>12008169</b>	514,00	659,00	814,00	1.237,00
L. 85	P. 35	<b>12008170</b>	451,00	592,00	719,00	1.050,00
	P. 46	<b>12008171</b>	527,00	683,00	835,00	1.237,00
	P. 51	<b>12008172</b>	527,00	683,00	835,00	1.237,00
	P. 62	<b>12008173</b>	523,00	692,00	856,00	1.314,00
L. 95	P. 35	<b>12008174</b>	487,00	643,00	777,00	1.130,00
	P. 46	<b>12008175</b>	551,00	722,00	881,00	1.305,00
	P. 51	<b>12008176</b>	551,00	722,00	881,00	1.305,00
	P. 62	<b>12008177</b>	589,00	768,00	944,00	1.423,00
L. 105	P. 35	<b>12008178</b>	495,00	665,00	807,00	1.180,00
	P. 46	<b>12008179</b>	565,00	749,00	915,00	1.361,00
	P. 51	<b>12008180</b>	565,00	749,00	915,00	1.361,00
	P. 62	<b>12008181</b>	603,00	799,00	980,00	1.481,00
L. 120	P. 35	<b>12008182</b>	554,00	743,00	898,00	1.303,00
	P. 46	<b>12008183</b>	623,00	831,00	1.008,00	1.488,00
	P. 51	<b>12008184</b>	623,00	831,00	1.008,00	1.488,00
	P. 62	<b>12008185</b>	647,00	865,00	1.061,00	1.590,00
L. 140	P. 35	<b>12008186</b>	577,00	793,00	968,00	1.412,00
	P. 46	<b>12008187</b>	652,00	883,00	1.078,00	1.600,00
	P. 51	<b>12008188</b>	652,00	883,00	1.078,00	1.600,00
	P. 62	<b>12008189</b>	696,00	937,00	1.149,00	1.722,00

**AIRY SISTEMA | BASI SOSPESSE H. 60 (25 SUP. + 35 INF.)**

AIRY SISTEMA  
WALL HUNG BASES H. 60

**BASE 2 CASSETTI**  
BASE W/2 DRAWERS

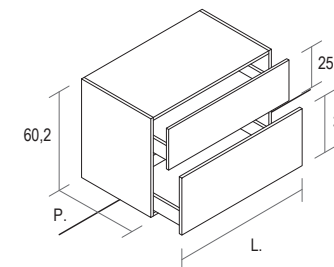

**ILLUMINAZIONE INTERNA DISPONIBILE**  
INTERNAL LIGHTING AVAILABLE

DIMENSIONI DIMENSIONS	CODICE CODE	①	②	③ ④ ⑤ ⑥	⑦	
L. 25	P. 35	<b>12034001</b>	428,00	484,00	561,00	767,00
	P. 46	<b>12034002</b>	471,00	542,00	643,00	922,00
	P. 51	<b>12034003</b>	471,00	542,00	643,00	922,00
	P. 62	<b>12034004</b>	497,00	581,00	697,00	1.029,00
L. 35	P. 35	<b>12034005</b>	450,00	519,00	604,00	832,00
	P. 46	<b>12034006</b>	497,00	583,00	691,00	993,00
	P. 51	<b>12034007</b>	497,00	583,00	691,00	993,00
	P. 62	<b>12034008</b>	526,00	622,00	747,00	1.100,00
L. 50	P. 35	<b>12034037</b>	484,00	573,00	674,00	931,00
	P. 46	<b>12034038</b>	537,00	643,00	764,00	1.096,00
	P. 51	<b>12034039</b>	537,00	643,00	764,00	1.096,00
	P. 62	<b>12034040</b>	567,00	683,00	822,00	1.206,00
L. 60	P. 35	<b>12034009</b>	506,00	610,00	718,00	997,00
	P. 46	<b>12034010</b>	564,00	682,00	813,00	1.166,00
	P. 51	<b>12034011</b>	564,00	682,00	813,00	1.166,00
	P. 62	<b>12034012</b>	595,00	725,00	873,00	1.277,00
L. 70	P. 35	<b>12034013</b>	529,00	647,00	763,00	1.062,00
	P. 46	<b>12034014</b>	590,00	723,00	862,00	1.234,00
	P. 51	<b>12034015</b>	590,00	723,00	862,00	1.234,00
	P. 62	<b>12034016</b>	621,00	763,00	918,00	1.344,00
L. 85	P. 35	<b>12034017</b>	577,00	713,00	843,00	1.172,00
	P. 46	<b>12034018</b>	643,00	794,00	947,00	1.352,00
	P. 51	<b>12034019</b>	643,00	794,00	947,00	1.352,00
	P. 62	<b>12034020</b>	679,00	841,00	1.010,00	1.468,00
L. 95	P. 35	<b>12034021</b>	600,00	751,00	889,00	1.239,00
	P. 46	<b>12034022</b>	672,00	838,00	999,00	1.424,00
	P. 51	<b>12034023</b>	672,00	838,00	999,00	1.424,00
	P. 62	<b>12034024</b>	709,00	885,00	1.063,00	1.542,00
L. 105	P. 35	<b>12034025</b>	612,00	777,00	922,00	1.294,00
	P. 46	<b>12034026</b>	698,00	877,00	1.047,00	1.494,00
	P. 51	<b>12034027</b>	698,00	877,00	1.047,00	1.494,00
	P. 62	<b>12034028</b>	737,00	927,00	1.113,00	1.611,00
L. 120	P. 35	<b>12034029</b>	660,00	844,00	1.005,00	1.408,00
	P. 46	<b>12034030</b>	741,00	939,00	1.123,00	1.600,00
	P. 51	<b>12034031</b>	741,00	939,00	1.123,00	1.600,00
	P. 62	<b>12034032</b>	781,00	992,00	1.191,00	1.721,00
L. 140	P. 35	<b>12034033</b>	709,00	920,00	1.098,00	1.542,00
	P. 46	<b>12034034</b>	794,00	1.019,00	1.221,00	1.739,00
	P. 51	<b>12034035</b>	794,00	1.019,00	1.221,00	1.739,00
	P. 62	<b>12034036</b>	838,00	1.074,00	1.291,00	1.862,00

**FINITURE/FINISHES:**  
① NOBILITATO; ② LACCATO OPACO; ③ LACCATO LUCIDO; ④ LACCATO METALLO; ⑤ IMPIALLACCIATO; ⑥ HPL; ⑦ RESINA CEMENTO  
① MELAMINE; ② MATT LACQUERED; ③ GLOSSY LACQUERED; ④ METAL LACQUERED; ⑤ VENEREED WOOD; ⑥ HPL; ⑦ RESIN CEMENT

**FINITURE/FINISHES:**  
① NOBILITATO; ② LACCATO OPACO; ③ LACCATO LUCIDO; ④ LACCATO METALLO; ⑤ IMPIALLACCIATO; ⑥ HPL; ⑦ RESINA CEMENTO  
① MELAMINE; ② MATT LACQUERED; ③ GLOSSY LACQUERED; ④ METAL LACQUERED; ⑤ VENEREED WOOD; ⑥ HPL; ⑦ RESIN CEMENT

**AIRY SISTEMA | BASI SOSPESSE H. 60 (35 SUP. + 25 INF.)**

AIRY SISTEMA  
WALL HUNG BASES H. 60

**BASE 2 CASSETTI**  
BASE W/2 DRAWERS

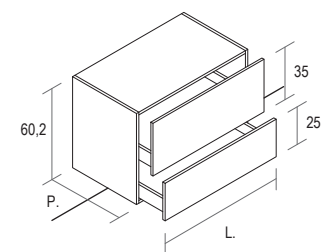

**ILLUMINAZIONE INTERNA DISPONIBILE**  
INTERNAL LIGHTING AVAILABLE

DIMENSIONI DIMENSIONS	CODICE CODE	①	②	③ ④ ⑤ ⑥	⑦	
L. 25	P. 35	<b>12034050</b>	428,00	484,00	561,00	767,00
	P. 46	<b>12034051</b>	471,00	542,00	643,00	922,00
	P. 51	<b>12034052</b>	471,00	542,00	643,00	922,00
	P. 62	<b>12034053</b>	497,00	581,00	697,00	1.029,00
L. 35	P. 35	<b>12034054</b>	450,00	519,00	604,00	832,00
	P. 46	<b>12034055</b>	497,00	583,00	691,00	993,00
	P. 51	<b>12034056</b>	497,00	583,00	691,00	993,00
	P. 62	<b>12034057</b>	526,00	622,00	747,00	1.100,00
L. 50	P. 35	<b>12034058</b>	484,00	573,00	674,00	931,00
	P. 46	<b>12034059</b>	537,00	643,00	764,00	1.096,00
	P. 51	<b>12034060</b>	537,00	643,00	764,00	1.096,00
	P. 62	<b>12034061</b>	567,00	683,00	822,00	1.206,00
L. 60	P. 35	<b>12034062</b>	506,00	610,00	718,00	997,00
	P. 46	<b>12034063</b>	564,00	682,00	813,00	1.166,00
	P. 51	<b>12034064</b>	564,00	682,00	813,00	1.166,00
	P. 62	<b>12034065</b>	595,00	725,00	873,00	1.277,00
L. 70	P. 35	<b>12034066</b>	529,00	647,00	763,00	1.062,00
	P. 46	<b>12034067</b>	590,00	723,00	862,00	1.234,00
	P. 51	<b>12034068</b>	590,00	723,00	862,00	1.234,00
	P. 62	<b>12034069</b>	621,00	763,00	918,00	1.344,00
L. 85	P. 35	<b>12034070</b>	577,00	713,00	843,00	1.172,00
	P. 46	<b>12034071</b>	643,00	794,00	947,00	1.352,00
	P. 51	<b>12034072</b>	643,00	794,00	947,00	1.352,00
	P. 62	<b>12034073</b>	679,00	841,00	1.010,00	1.468,00
L. 95	P. 35	<b>12034074</b>	600,00	751,00	889,00	1.239,00
	P. 46	<b>12034075</b>	672,00	838,00	999,00	1.424,00
	P. 51	<b>12034076</b>	672,00	838,00	999,00	1.424,00
	P. 62	<b>12034077</b>	709,00	885,00	1.063,00	1.542,00
L. 105	P. 35	<b>12034078</b>	612,00	777,00	922,00	1.294,00
	P. 46	<b>12034079</b>	698,00	877,00	1.047,00	1.494,00
	P. 51	<b>12034080</b>	698,00	877,00	1.047,00	1.494,00
	P. 62	<b>12034081</b>	737,00	927,00	1.113,00	1.611,00
L. 120	P. 35	<b>12034082</b>	660,00	844,00	1.005,00	1.408,00
	P. 46	<b>12034083</b>	741,00	939,00	1.123,00	1.600,00
	P. 51	<b>12034084</b>	741,00	939,00	1.123,00	1.600,00
	P. 62	<b>12034085</b>	781,00	992,00	1.191,00	1.721,00
L. 140	P. 35	<b>12034086</b>	709,00	920,00	1.098,00	1.542,00
	P. 46	<b>12034087</b>	794,00	1.019,00	1.221,00	1.739,00
	P. 51	<b>12034088</b>	794,00	1.019,00	1.221,00	1.739,00
	P. 62	<b>12034089</b>	838,00	1.074,00	1.291,00	1.862,00

**AIRY SISTEMA | BASI SOSPESSE H. 60**

AIRY SISTEMA  
WALL HUNG BASES H. 60

**BASE 1 ANTA**  
BASE W/1 DOOR

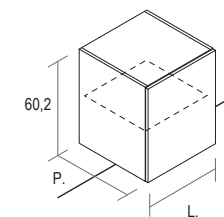

DIMENSIONI DIMENSIONS	CODICE CODE	①	②	③ ④ ⑤ ⑥	⑦	
L. 15	P. 22	<b>12001075</b>	176,00	221,00	278,00	419,00
	P. 35	<b>12001076</b>	204,00	262,00	338,00	539,00
	P. 46	<b>12001077</b>	240,00	315,00	413,00	687,00
	P. 51	<b>12001078</b>	240,00	315,00	413,00	687,00
L. 20	P. 62	<b>12001079</b>	267,00	353,00	467,00	794,00
	P. 22	<b>12001080</b>	176,00	221,00	278,00	419,00
	P. 35	<b>12001081</b>	204,00	262,00	338,00	539,00
	P. 46	<b>12001082</b>	240,00	315,00	413,00	687,00
L. 25	P. 51	<b>12001083</b>	240,00	315,00	413,00	687,00
	P. 62	<b>12001084</b>	267,00	353,00	467,00	794,00
	P. 22	<b>12001085</b>	176,00	221,00	278,00	419,00
	P. 35	<b>12001086</b>	204,00	262,00	338,00	539,00
L. 30	P. 46	<b>12001087</b>	240,00	315,00	413,00	687,00
	P. 51	<b>12001088</b>	240,00	315,00	413,00	687,00
	P. 62	<b>12001089</b>	267,00	353,00	467,00	794,00
	P. 22	<b>12001090</b>	189,00	248,00	314,00	474,00
L. 35	P. 35	<b>12001091</b>	221,00	294,00	377,00	599,00
	P. 46	<b>12001092</b>	261,00	348,00	456,00	750,00
	P. 51	<b>12001093</b>	261,00	348,00	456,00	750,00
	P. 62	<b>12001094</b>	299,00	397,00	521,00	868,00
L. 40	P. 22	<b>12001095</b>	189,00	248,00	314,00	474,00
	P. 35	<b>12001096</b>	221,00	294,00	377,00	599,00
	P. 46	<b>12001097</b>	261,00	348,00	456,00	750,00
	P. 51	<b>12001098</b>	261,00	348,00	456,00	750,00
L. 45	P. 62	<b>12001099</b>	299,00	397,00	521,00	868,00
	P. 22	<b>12001100</b>	209,00	289,00	368,00	559,00
	P. 35	<b>12001101</b>	239,00	330,00	423,00	661,00
	P. 46	<b>12001102</b>	294,00	402,00	522,00	848,00
L. 50	P. 51	<b>12001103</b>	294,00	402,00	522,00	848,00
	P. 62	<b>12001104</b>	326,00	444,00	581,00	959,00

**FINITURE/FINISHES:**  
① NOBILITATO; ② LACCATO OPACO; ③ LACCATO LUCIDO; ④ LACCATO METALLO; ⑤ IMPIALLACCIATO; ⑥ HPL; ⑦ RESINA CEMENTO  
① MELAMINE; ② MATT LACQUERED; ③ GLOSSY LACQUERED; ④ METAL LACQUERED; ⑤ VENEREED WOOD; ⑥ HPL; ⑦ RESIN CEMENT

**FINITURE/FINISHES:**  
① NOBILITATO; ② LACCATO OPACO; ③ LACCATO LUCIDO; ④ LACCATO METALLO; ⑤ IMPIALLACCIATO; ⑥ HPL; ⑦ RESINA CEMENTO  
① MELAMINE; ② MATT LACQUERED; ③ GLOSSY LACQUERED; ④ METAL LACQUERED; ⑤ VENEREED WOOD; ⑥ HPL; ⑦ RESIN CEMENT

## AIRY SISTEMA | BASI SOSPESSE H. 60

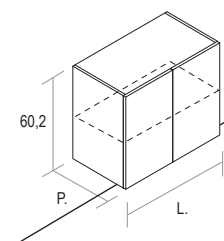
AIRY SISTEMA  
WALL HUNG BASES H. 60BASE 2 ANTE  
BASE W/2 DOORS

DIMENSIONI DIMENSIONS	CODICE CODE	①	②	③ ④ ⑤ ⑥	⑦	
L. 50	P. 22	<b>12006058</b>	236,00	311,00	393,00	583,00
	P. 35	<b>12006059</b>	271,00	362,00	461,00	712,00
L. 60	P. 46	<b>12006060</b>	319,00	425,00	548,00	872,00
	P. 51	<b>12006061</b>	319,00	425,00	548,00	872,00
L. 70	P. 62	<b>12006062</b>	355,00	471,00	610,00	986,00
	P. 22	<b>12006063</b>	249,00	340,00	429,00	639,00
L. 85	P. 35	<b>12006064</b>	293,00	396,00	504,00	775,00
	P. 46	<b>12006065</b>	338,00	456,00	587,00	932,00
L. 100	P. 51	<b>12006066</b>	338,00	456,00	587,00	932,00
	P. 62	<b>12006067</b>	374,00	504,00	650,00	1.047,00
L. 105	P. 22	<b>12006068</b>	265,00	369,00	467,00	697,00
	P. 35	<b>12006069</b>	309,00	425,00	542,00	834,00
L. 120	P. 46	<b>12006070</b>	366,00	499,00	639,00	1.004,00
	P. 51	<b>12006071</b>	366,00	499,00	639,00	1.004,00
L. 135	P. 62	<b>12006072</b>	403,00	546,00	703,00	1.120,00
	P. 22	<b>12006073</b>	294,00	419,00	529,00	791,00
L. 150	P. 35	<b>12006074</b>	335,00	472,00	601,00	923,00
	P. 46	<b>12006075</b>	395,00	548,00	699,00	1.096,00
L. 165	P. 51	<b>12006076</b>	395,00	548,00	699,00	1.096,00
	P. 62	<b>12006077</b>	439,00	601,00	770,00	1.220,00
L. 180	P. 22	<b>12006078</b>	310,00	450,00	568,00	850,00
	P. 35	<b>12006079</b>	354,00	504,00	643,00	985,00
L. 195	P. 46	<b>12006080</b>	417,00	583,00	743,00	1.161,00
	P. 51	<b>12006081</b>	417,00	583,00	743,00	1.161,00
L. 210	P. 62	<b>12006082</b>	462,00	637,00	816,00	1.286,00
	P. 22	<b>12006083</b>	310,00	456,00	579,00	871,00
L. 225	P. 35	<b>12006084</b>	364,00	521,00	664,00	1.016,00
	P. 46	<b>12006085</b>	433,00	604,00	770,00	1.198,00
L. 240	P. 51	<b>12006086</b>	433,00	604,00	770,00	1.198,00
	P. 62	<b>12006087</b>	482,00	664,00	846,00	1.326,00
L. 255	P. 22	<b>12006088</b>	318,00	469,00	598,00	900,00
	P. 35	<b>12006089</b>	373,00	537,00	685,00	1.047,00
L. 270	P. 46	<b>12006090</b>	442,00	622,00	792,00	1.231,00
	P. 51	<b>12006091</b>	442,00	622,00	792,00	1.231,00
L. 285	P. 62	<b>12006092</b>	493,00	683,00	870,00	1.360,00

## FINITURE/FINISHES:

① NOBILITATO; ② LACCATO OPACO; ③ LACCATO LUCIDO; ④ LACCATO METALLO; ⑤ IMPIALLACCIATO; ⑥ HPL; ⑦ RESINA CEMENTO  
① MELAMINE; ② MATT LACQUERED; ③ GLOSSY LACQUERED; ④ METAL LACQUERED; ⑤ VENEREED WOOD; ⑥ HPL; ⑦ RESIN CEMENT

## AIRY SISTEMA | BASI SOSPESSE H. 60

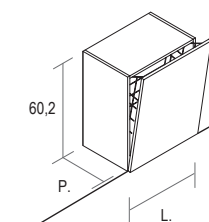
AIRY SISTEMA  
WALL HUNG BASES H. 60BASE 1 ANTA RIBALTA CON  
CESTO PORTABIANCHERIA  
FLIP-DOWN DOOR BASE W/LAUNDRY  
BASKETDIM. CESTO PORTABIANCHERIA  
H. 43 L. 27/40 P. 28  
LAUNDRY BASKET DIM.  
H. 43 W. 27/40 D. 28

DIMENSIONI DIMENSIONS	CODICE CODE	①	②	③ ④ ⑤ ⑥	⑦	
L. 35	P. 35	<b>12804036</b>	293,00	364,00	450,00	672,00
	P. 46	<b>12804037</b>	332,00	419,00	526,00	823,00
L. 50	P. 51	<b>12804038</b>	332,00	419,00	526,00	823,00
	P. 62	<b>12804039</b>	360,00	458,00	582,00	932,00
L. 65	P. 35	<b>12804040</b>	340,00	433,00	529,00	785,00
	P. 46	<b>12804041</b>	385,00	493,00	612,00	941,00
L. 80	P. 51	<b>12804042</b>	385,00	493,00	612,00	941,00
	P. 62	<b>12804043</b>	411,00	529,00	665,00	1.047,00

## FINITURE/FINISHES:

① NOBILITATO; ② LACCATO OPACO; ③ LACCATO LUCIDO; ④ LACCATO METALLO; ⑤ IMPIALLACCIATO; ⑥ HPL; ⑦ RESINA CEMENTO  
① MELAMINE; ② MATT LACQUERED; ③ GLOSSY LACQUERED; ④ METAL LACQUERED; ⑤ VENEREED WOOD; ⑥ HPL; ⑦ RESIN CEMENT

## AIRY SISTEMA | BASI SOSPESSE H. 60 (25 SUP. + 35 INF.)

AIRY SISTEMA  
WALL HUNG BASES H. 60

	DIMENSIONI DIMENSIONS	CODICE CODE	①	②	③ ④ ⑤ ⑥	⑦	
<b>BASE A GIORNO</b> OPEN BASE	L. 25	P. 35	13017053	207,00	386,00	461,00	-
		P. 46	13017054	249,00	504,00	605,00	-
		P. 51	13017055	249,00	504,00	605,00	-
		P. 62	13017056	280,00	588,00	709,00	-
	L. 35	P. 35	13017057	226,00	430,00	517,00	-
		P. 46	13017058	272,00	564,00	680,00	-
		P. 51	13017059	272,00	564,00	680,00	-
		P. 62	13017060	306,00	658,00	795,00	-
	L. 50	P. 35	13017061	261,00	506,00	612,00	-
		P. 46	13017062	318,00	661,00	803,00	-
		P. 51	13017063	318,00	661,00	803,00	-
		P. 62	13017064	358,00	772,00	938,00	-
<b>BASE A GIORNO PER CAMBIO DI PROFONDITÀ DX-SX</b> DEPTH-CHANGING OPEN BASE	L. 25	P. 35 - 46	13417050	324,00	605,00	726,00	-
		P. 35 - 51	13417051	324,00	605,00	726,00	-
	L. 35	P. 35 - 46	13417052	354,00	677,00	816,00	-
		P. 35 - 51	13417053	354,00	677,00	816,00	-
L. 50	P. 35 - 46	13417054	414,00	794,00	964,00	-	
	P. 35 - 51	13417055	414,00	794,00	964,00	-	
<b>BASE TERMINALE A GIORNO DX-SX</b> OPEN SIDE-BASE	L. 15	P. 35	12717010	145,00	232,00	293,00	435,00*
		P. 46	12717011	177,00	293,00	371,00	561,00*
	L. 15	P. 51	12717012	177,00	293,00	371,00	561,00*
		P. 62	12717013	198,00	331,00	422,00	644,00*

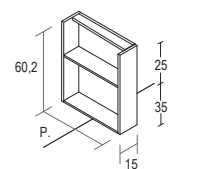
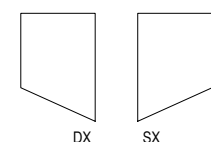
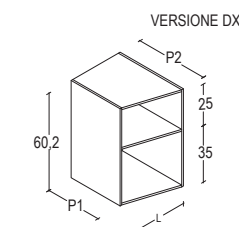
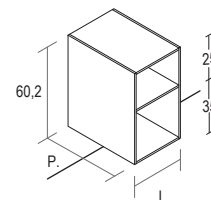

\*LA VARIANTE IN FINITURA RESINA CEMENTO E' DISPONIBILE SOLO PER IL FRONTALE, MENTRE LA PARTE A GIORNO INTERNA SARA' REALIZZATA IN UN'ALTRA FINITURA DA SPECIFICARE IN FASE D'ORDINE.

\*THE CEMENT RESIN FINISH IS AVAILABLE FOR FRONTS ONLY. THE FINISH OF THE SIDE-OPEN COMPARTMENT MUST BE SPECIFIED IN THE ORDER.

## FINITURE/FINISHES:

① NOBILITATO; ② LACCATO OPACO; ③ LACCATO LUCIDO; ④ LACCATO METALLO; ⑤ IMPIALLACCIATO; ⑥ HPL; ⑦ RESINA CEMENTO

① MELAMINE; ② MATT LACQUERED; ③ GLOSSY LACQUERED; ④ METAL LACQUERED; ⑤ VENEREED WOOD; ⑥ HPL; ⑦ RESIN CEMENT

## AIRY SISTEMA | BASI SOSPESSE H. 60 (35 SUP. + 25 INF.)

AIRY SISTEMA  
WALL HUNG BASES H. 60

	DIMENSIONI DIMENSIONS	CODICE CODE	①	②	③ ④ ⑤ ⑥	⑦	
<b>BASE A GIORNO</b> OPEN BASE	L. 25	P. 35	13017065	207,00	386,00	461,00	-
		P. 46	13017066	249,00	504,00	605,00	-
		P. 51	13017067	249,00	504,00	605,00	-
		P. 62	13017068	280,00	588,00	709,00	-
	L. 35	P. 35	13017069	226,00	430,00	517,00	-
		P. 46	13017070	272,00	564,00	680,00	-
		P. 51	13017071	272,00	564,00	680,00	-
		P. 62	13017072	306,00	658,00	795,00	-
	L. 50	P. 35	13017073	261,00	506,00	612,00	-
		P. 46	13017074	318,00	661,00	803,00	-
		P. 51	13017075	318,00	661,00	803,00	-
		P. 62	13017076	358,00	772,00	938,00	-
<b>BASE A GIORNO PER CAMBIO DI PROFONDITÀ DX-SX</b> DEPTH-CHANGING OPEN BASE	L. 25	P. 35 - 46	13417065	324,00	605,00	726,00	-
		P. 35 - 51	13417066	324,00	605,00	726,00	-
	L. 35	P. 35 - 46	13417067	354,00	677,00	816,00	-
		P. 35 - 51	13417068	354,00	677,00	816,00	-
L. 50	P. 35 - 46	13417069	414,00	794,00	964,00	-	
	P. 35 - 51	13417070	414,00	794,00	964,00	-	
<b>BASE TERMINALE A GIORNO DX-SX</b> OPEN SIDE-BASE	L. 15	P. 35	12717015	145,00	232,00	293,00	435,00*
		P. 46	12717016	177,00	293,00	371,00	561,00*
	L. 15	P. 51	12717017	177,00	293,00	371,00	561,00*
		P. 62	12717018	198,00	331,00	422,00	644,00*

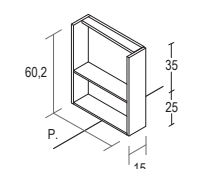
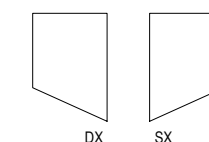
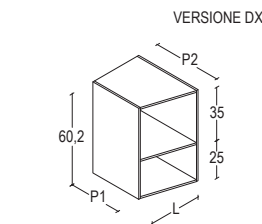
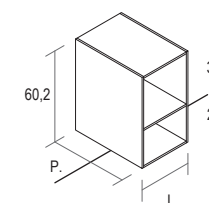

\*LA VARIANTE IN FINITURA RESINA CEMENTO E' DISPONIBILE SOLO PER IL FRONTALE, MENTRE LA PARTE A GIORNO INTERNA SARA' REALIZZATA IN UN'ALTRA FINITURA DA SPECIFICARE IN FASE D'ORDINE.

\*THE CEMENT RESIN FINISH IS AVAILABLE FOR FRONTS ONLY. THE FINISH OF THE SIDE-OPEN COMPARTMENT MUST BE SPECIFIED IN THE ORDER.

## FINITURE/FINISHES:

① NOBILITATO; ② LACCATO OPACO; ③ LACCATO LUCIDO; ④ LACCATO METALLO; ⑤ IMPIALLACCIATO; ⑥ HPL; ⑦ RESINA CEMENTO

① MELAMINE; ② MATT LACQUERED; ③ GLOSSY LACQUERED; ④ METAL LACQUERED; ⑤ VENEREED WOOD; ⑥ HPL; ⑦ RESIN CEMENT

**AIRY SISTEMA  
BASI SOSPESSE H. 75  
BASI A TERRA CON ZOCCOLO  
H. 6-10-15 O PIEDINI REGOLABILI**

*AIRY SISTEMA  
WALL HUNG BASES H. 75  
FLOOR-STANDING BASES  
WITH 6-10-15 CM HIGH PLINTH OR  
ADJUSTABLE FEET*

**AIRY SISTEMA | ACCESSORI PER BASI H. 75 - OPZIONALI**

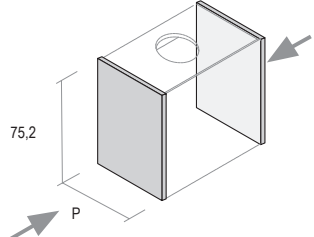
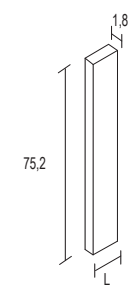
AIRY SISTEMA ACCESSORIES FOR BASES H. 75		DIMENSIONI DIMENSIONS	CODICE CODE	①	②	③	④	⑤	⑥	⑦
<b>FIANCO DI FINITURA SP. 1,2</b> ADDITIONAL FINISHING SIDE-PANEL TH. 1.2 	P. 35	<b>19000011</b>	102,00	172,00	190,00					403,00
	P. 46	<b>19000012</b>	125,00	185,00	215,00					519,00
	P. 51	<b>19000013</b>	125,00	185,00	215,00					519,00
	P. 62	<b>19000026</b>	130,00	195,00	250,00					672,00
<b>FASCIA DI TAMPONAMENTO PER BASE H. 75</b> FILLER WOODEN-STRIP FOR BASES H.75 		H. 75 L. 5 - 15	<b>19126009</b>	106,00	158,00	173,00				279,00

**N.B. I PREZZI SI RIFERISCONO AD UN SINGOLO FIANCO**  
 N.B. : THE PRICES REFER TO A SINGLE SIDE-PANEL

**FINITURE/FINISHES:**  
 ① NOBILITATO; ② LACCATO OPACO; ③ LACCATO LUCIDO; ④ LACCATO METALLO; ⑤ IMPIALLACCIATO; ⑥ HPL; ⑦ RESINA CEMENTO  
 ① MELAMINE; ② MATT LACQUERED; ③ GLOSSY LACQUERED; ④ METAL LACQUERED; ⑤ VENEREED WOOD; ⑥ HPL; ⑦ RESIN CEMENT

**AIRY SISTEMA | BASI SOSPESSE H. 75 / BASI A TERRA CON ZOCCOLO H. 6-10-15 O PIEDINI REGOLABILI**

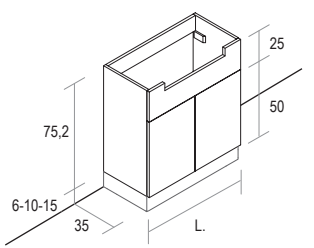
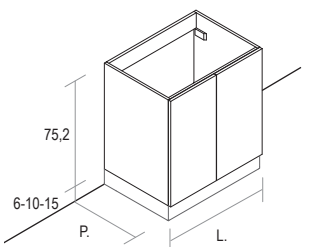
AIRY SISTEMA WALL HUNG BASES H. 75 FLOOR-STANDING BASES WITH 6-10-15 PLINTH OR ADJUSTABLE FEET		DIMENSIONI DIMENSIONS	CODICE CODE	①	②	③	④	⑤	⑥	⑦	
<b>BASE LAVABO FRONTALE FISSO + 2 ANTE</b> WASHBASIN BASE W/1 FIXED FRONT + 2 DOORS 	L. 70 P. 35	<b>10616001</b>	458,00	604,00	751,00					1.119,00	
	L. 85 P. 35	<b>10616002</b>	497,00	669,00	834,00					1.239,00	
	L. 95 P. 35	<b>10616003</b>	534,00	723,00	899,00					1.330,00	
	L. 105 P. 35	<b>10616004</b>	565,00	769,00	955,00					1.415,00	
<b>BASE LAVABO 2 ANTE</b> WASHBASIN BASE W/2 DOORS 	P. 35	<b>10406007</b>	390,00	522,00	655,00					999,00	
	L. 60	P. 46	<b>10406001</b>	444,00	597,00	758,00					1.194,00
		P. 51	<b>10406002</b>	444,00	597,00	758,00					1.194,00
		P. 62	<b>10406008</b>	485,00	650,00	833,00					1.333,00
	L. 70	P. 35	<b>10406009</b>	411,00	560,00	706,00					1.074,00
		P. 46	<b>10406003</b>	466,00	635,00	808,00					1.269,00
		P. 51	<b>10406004</b>	466,00	635,00	808,00					1.269,00
	L. 85	P. 62	<b>10406010</b>	506,00	690,00	883,00					1.411,00
		P. 35	<b>10406011</b>	464,00	641,00	801,00					1.209,00
		P. 46	<b>10406005</b>	522,00	717,00	906,00					1.408,00
	L. 95	P. 51	<b>10406006</b>	522,00	717,00	906,00					1.408,00
		P. 62	<b>10406012</b>	565,00	774,00	983,00					1.550,00
P. 35		<b>10406013</b>	495,00	687,00	859,00					1.294,00	
L. 100	P. 46	<b>10406014</b>	551,00	763,00	964,00					1.491,00	
	P. 51	<b>10406015</b>	551,00	763,00	964,00					1.491,00	
	P. 62	<b>10406016</b>	589,00	816,00	1.036,00					1.630,00	
L. 105	P. 35	<b>10406030</b>	493,00	698,00	866,00					1.306,00	
	P. 46	<b>10406020</b>	570,00	801,00	1.002,00					1.544,00	
	P. 51	<b>10406021</b>	570,00	801,00	1.002,00					1.544,00	
L. 105	P. 62	<b>10406022</b>	616,00	852,00	1.080,00					1.690,00	
	P. 35	<b>10406031</b>	512,00	735,00	904,00					1.359,00	
	P. 46	<b>10406026</b>	589,00	838,00	1.040,00					1.597,00	
	P. 51	<b>10406027</b>	589,00	838,00	1.040,00					1.597,00	
P. 62	<b>10406028</b>	630,00	877,00	1.112,00					1.736,00		

**FINITURE/FINISHES:**  
 ① NOBILITATO; ② LACCATO OPACO; ③ LACCATO LUCIDO; ④ LACCATO METALLO; ⑤ IMPIALLACCIATO; ⑥ HPL; ⑦ RESINA CEMENTO  
 ① MELAMINE; ② MATT LACQUERED; ③ GLOSSY LACQUERED; ④ METAL LACQUERED; ⑤ VENEREED WOOD; ⑥ HPL; ⑦ RESIN CEMENT



**AIRY SISTEMA | BASI SOSPESSE H. 75 / BASI A TERRA CON ZOCCOLO H. 6-10-15 O PIEDINI REGOLABILI**

AIRY SISTEMA  
WALL HUNG BASES H. 75  
FLOOR-STANDING BASES WITH 6-10-15  
PLINTH OR ADJUSTABLE FEET

**BASE LAVABO 2 ANTE H. 50  
1 CASSETTO H. 25**  
WASHBASIN BASE W/1 LOWER DRAWER  
AND 2 UPPER DOORS

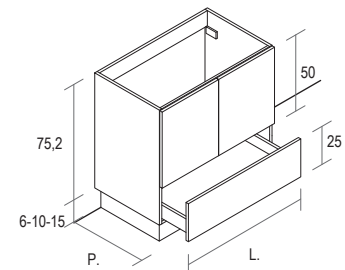

**ILLUMINAZIONE INTERNA  
DISPONIBILE SOLO PER  
CASSETTO**  
INTERNAL LIGHTING AVAILABLE  
ONLY FOR DRAWER

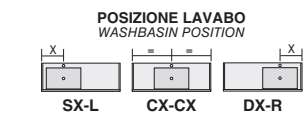

DIMENSIONI DIMENSIONS	CODICE CODE	①	②	③ ④ ⑤ ⑥	⑦	
L. 60	P. 35	<b>10438001</b>	672,00	799,00	932,00	1.273,00
	P. 46	<b>10438002</b>	741,00	885,00	1.046,00	1.483,00
	P. 51	<b>10438003</b>	741,00	885,00	1.046,00	1.483,00
	P. 62	<b>10438004</b>	785,00	943,00	1.125,00	1.627,00
L. 70	P. 35	<b>10438005</b>	697,00	839,00	982,00	1.351,00
	P. 46	<b>10438006</b>	770,00	931,00	1.102,00	1.565,00
	P. 51	<b>10438007</b>	770,00	931,00	1.102,00	1.565,00
	P. 62	<b>10438008</b>	816,00	992,00	1.183,00	1.710,00
L. 85	P. 35	<b>10438009</b>	772,00	937,00	1.097,00	1.504,00
	P. 46	<b>10438010</b>	849,00	1.035,00	1.223,00	1.723,00
	P. 51	<b>10438011</b>	849,00	1.035,00	1.223,00	1.723,00
	P. 62	<b>10438012</b>	899,00	1.098,00	1.305,00	1.872,00
L. 95	P. 35	<b>10438013</b>	822,00	1.004,00	1.174,00	1.608,00
	P. 46	<b>10438014</b>	903,00	1.103,00	1.302,00	1.828,00
	P. 51	<b>10438015</b>	903,00	1.103,00	1.302,00	1.828,00
	P. 62	<b>10438016</b>	947,00	1.162,00	1.381,00	1.971,00
L. 105	P. 35	<b>10438017</b>	833,00	1.025,00	1.201,00	1.649,00
	P. 46	<b>10438018</b>	910,00	1.128,00	1.337,00	1.887,00
	P. 51	<b>10438019</b>	910,00	1.128,00	1.337,00	1.887,00
	P. 62	<b>10438020</b>	971,00	1.201,00	1.431,00	2.048,00
L. 60	P. 35	<b>10439001</b>	612,00	741,00	874,00	1.220,00
	P. 46	<b>10439002</b>	672,00	817,00	978,00	1.413,00
	P. 51	<b>10439003</b>	672,00	817,00	978,00	1.413,00
	P. 62	<b>10439004</b>	713,00	872,00	1.053,00	1.553,00
L. 70	P. 35	<b>10439005</b>	633,00	775,00	918,00	1.286,00
	P. 46	<b>10439006</b>	698,00	859,00	1.031,00	1.490,00
	P. 51	<b>10439007</b>	698,00	859,00	1.031,00	1.490,00
	P. 62	<b>10439008</b>	740,00	915,00	1.106,00	1.632,00
L. 85	P. 35	<b>10439009</b>	720,00	885,00	1.046,00	1.451,00
	P. 46	<b>10439010</b>	769,00	953,00	1.141,00	1.639,00
	P. 51	<b>10439011</b>	769,00	953,00	1.141,00	1.639,00
	P. 62	<b>10439012</b>	812,00	1.010,00	1.220,00	1.781,00
L. 95	P. 35	<b>10439013</b>	741,00	922,00	1.094,00	1.522,00
	P. 46	<b>10439014</b>	813,00	1.014,00	1.213,00	1.736,00
	P. 51	<b>10439015</b>	813,00	1.014,00	1.213,00	1.736,00
	P. 62	<b>10439016</b>	857,00	1.073,00	1.292,00	1.881,00
L. 105	P. 35	<b>10439017</b>	768,00	960,00	1.138,00	1.583,00
	P. 46	<b>10439018</b>	841,00	1.059,00	1.269,00	1.817,00
	P. 51	<b>10439019</b>	841,00	1.059,00	1.269,00	1.817,00
	P. 62	<b>10439020</b>	888,00	1.119,00	1.348,00	1.961,00

**FINITURE/FINISHES:**

① NOBILITATO; ② LACCATO OPACO; ③ LACCATO LUCIDO; ④ LACCATO METALLO; ⑤ IMPIALLACCIATO; ⑥ HPL; ⑦ RESINA CEMENTO  
① MELAMINE; ② MATT LACQUERED; ③ GLOSSY LACQUERED; ④ METAL LACQUERED; ⑤ VENEREED WOOD; ⑥ HPL; ⑦ RESIN CEMENT

**AIRY SISTEMA | BASI SOSPESSE H. 75 / BASI A TERRA CON ZOCCOLO H. 6-10-15 O PIEDINI REGOLABILI**

AIRY SISTEMA  
WALL HUNG BASES H. 75  
FLOOR-STANDING BASES WITH 6-10-15  
PLINTH OR ADJUSTABLE FEET

**BASE LAVABO 1 CASSETTO H. 25  
1 CASSETTONE H. 50**  
WASHBASIN BASE W/1 UPPER DRAWER  
H. 25 AND 1 LOWER DRAWER H. 50

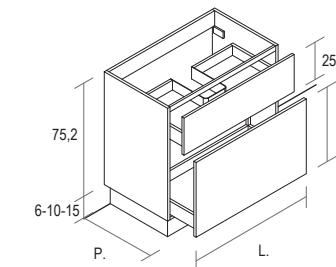

**ILLUMINAZIONE INTERNA  
DISPONIBILE**  
INTERNAL LIGHTING AVAILABLE

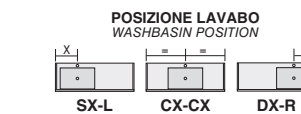

DIMENSIONI DIMENSIONS	CODICE CODE	①	②	③ ④ ⑤ ⑥	⑦	
L. 60	P. 35	<b>10440001</b>	714,00	848,00	981,00	1.335,00
	P. 46	<b>10440002</b>	780,00	933,00	1.095,00	1.542,00
	P. 51	<b>10440003</b>	780,00	933,00	1.095,00	1.542,00
	P. 62	<b>10440004</b>	821,00	986,00	1.168,00	1.681,00
L. 70	P. 35	<b>10440005</b>	739,00	888,00	1.032,00	1.413,00
	P. 46	<b>10440006</b>	811,00	980,00	1.152,00	1.626,00
	P. 51	<b>10440007</b>	811,00	980,00	1.152,00	1.626,00
	P. 62	<b>10440008</b>	851,00	1.035,00	1.227,00	1.767,00
L. 85	P. 35	<b>10440009</b>	808,00	983,00	1.145,00	1.566,00
	P. 46	<b>10440010</b>	887,00	1.081,00	1.270,00	1.785,00
	P. 51	<b>10440011</b>	887,00	1.081,00	1.270,00	1.785,00
	P. 62	<b>10440012</b>	931,00	1.139,00	1.348,00	1.928,00
L. 95	P. 35	<b>10440013</b>	854,00	1.046,00	1.218,00	1.665,00
	P. 46	<b>10440014</b>	936,00	1.149,00	1.347,00	1.888,00
	P. 51	<b>10440015</b>	936,00	1.149,00	1.347,00	1.888,00
	P. 62	<b>10440016</b>	980,00	1.206,00	1.425,00	2.032,00
L. 105	P. 35	<b>10440017</b>	887,00	1.097,00	1.280,00	1.753,00
	P. 46	<b>10440018</b>	959,00	1.189,00	1.398,00	1.966,00
	P. 51	<b>10440019</b>	959,00	1.189,00	1.398,00	1.966,00
	P. 62	<b>10440020</b>	1.005,00	1.249,00	1.479,00	2.112,00

**FINITURE/FINISHES:**

① NOBILITATO; ② LACCATO OPACO; ③ LACCATO LUCIDO; ④ LACCATO METALLO; ⑤ IMPIALLACCIATO; ⑥ HPL; ⑦ RESINA CEMENTO  
① MELAMINE; ② MATT LACQUERED; ③ GLOSSY LACQUERED; ④ METAL LACQUERED; ⑤ VENEREED WOOD; ⑥ HPL; ⑦ RESIN CEMENT

**AIRY SISTEMA | BASI SOSPESSE H. 75 / BASI A TERRA CON ZOCCOLO H. 6-10-15 O PIEDINI REGOLABILI**

AIRY SISTEMA WALL HUNG BASES H. 75 FLOOR-STANDING BASES WITH 6-10-15 PLINTH OR ADJUSTABLE FEET		DIMENSIONI DIMENSIONS	CODICE CODE	①	②	③ ④ ⑤ ⑥	⑦
<b>BASE LAVABO 3 CASSETTI</b> WASHBASIN BASE W/3 DRAWERS	P. 35	<b>10411009</b>		971,00	1.097,00	1.229,00	1.583,00
	P. 46	<b>10411001</b>		1.045,00	1.190,00	1.352,00	1.799,00
	P. 51	<b>10411002</b>		1.045,00	1.190,00	1.352,00	1.799,00
L. 60	P. 62	<b>10411010</b>		1.086,00	1.245,00	1.425,00	1.937,00
	P. 35	<b>10411011</b>		1.001,00	1.141,00	1.286,00	1.664,00
	P. 46	<b>10411003</b>		1.079,00	1.240,00	1.413,00	1.884,00
L. 70	P. 51	<b>10411004</b>		1.079,00	1.240,00	1.413,00	1.884,00
	P. 62	<b>10411012</b>		1.122,00	1.295,00	1.488,00	2.025,00
	P. 35	<b>10411013</b>		1.089,00	1.253,00	1.413,00	1.830,00
L. 85	P. 46	<b>10411005</b>		1.174,00	1.359,00	1.548,00	2.058,00
	P. 51	<b>10411006</b>		1.174,00	1.359,00	1.548,00	2.058,00
	P. 62	<b>10411014</b>		1.218,00	1.417,00	1.626,00	2.201,00
L. 95	P. 35	<b>10411015</b>		1.152,00	1.332,00	1.504,00	1.947,00
	P. 46	<b>10411016</b>		1.242,00	1.444,00	1.642,00	2.179,00
	P. 51	<b>10411017</b>		1.242,00	1.444,00	1.642,00	2.179,00
L. 105	P. 62	<b>10411018</b>		1.280,00	1.494,00	1.713,00	2.314,00
	P. 35	<b>10411019</b>		1.189,00	1.386,00	1.568,00	2.035,00
	P. 46	<b>10411007</b>		1.281,00	1.496,00	1.707,00	2.269,00
L. 120	P. 51	<b>10411008</b>		1.281,00	1.496,00	1.707,00	2.269,00
	P. 62	<b>10411020</b>		1.326,00	1.556,00	1.788,00	2.413,00
	P. 35	<b>10411021</b>		1.260,00	1.482,00	1.680,00	2.185,00
L. 140	P. 46	<b>10411022</b>		1.359,00	1.600,00	1.827,00	2.426,00
	P. 51	<b>10411023</b>		1.359,00	1.600,00	1.827,00	2.426,00
	P. 62	<b>10411024</b>		1.408,00	1.663,00	1.909,00	2.573,00
L. 140	P. 35	<b>10411025</b>		1.377,00	1.631,00	1.851,00	2.407,00
	P. 46	<b>10411026</b>		1.464,00	1.737,00	1.986,00	2.636,00
	P. 51	<b>10411027</b>		1.464,00	1.737,00	1.986,00	2.636,00
	P. 62	<b>10411028</b>		1.517,00	1.803,00	2.072,00	2.788,00

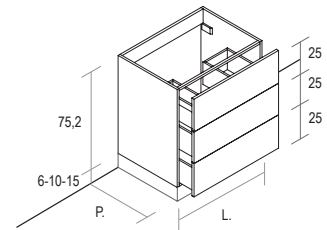

**ILLUMINAZIONE INTERNA DISPONIBILE**  
INTERNAL LIGHTING AVAILABLE

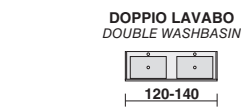
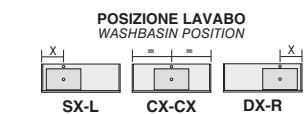

**FINITURE/FINISHES:**  
① NOBILITATO; ② LACCATO OPACO; ③ LACCATO LUCIDO; ④ LACCATO METALLO; ⑤ IMPIALLACCIATO; ⑥ HPL; ⑦ RESINA CEMENTO  
① MELAMINE; ② MATT LACQUERED; ③ GLOSSY LACQUERED; ④ METAL LACQUERED; ⑤ VENEREED WOOD; ⑥ HPL; ⑦ RESIN CEMENT

**AIRY SISTEMA | BASI SOSPESSE H. 75 / BASI A TERRA CON ZOCCOLO H. 6-10-15 O PIEDINI REGOLABILI**

AIRY SISTEMA WALL HUNG BASES H. 75 FLOOR-STANDING BASES WITH 6-10-15 PLINTH OR ADJUSTABLE FEET		DIMENSIONI DIMENSIONS	CODICE CODE	①	②	③ ④ ⑤ ⑥	⑦
<b>BASE 1 ANTA DX-SX</b> BASE W/1 DOOR R-L	P. 35	<b>10101001</b>		272,00	347,00	440,00	693,00
	P. 46	<b>10101002</b>		321,00	414,00	537,00	882,00
	P. 51	<b>10101003</b>		321,00	414,00	537,00	882,00
L. 15	P. 62	<b>10101020</b>		358,00	467,00	609,00	1.019,00
	P. 35	<b>10101004</b>		272,00	347,00	440,00	693,00
	P. 46	<b>10101005</b>		321,00	414,00	537,00	882,00
L. 20	P. 51	<b>10101006</b>		321,00	414,00	537,00	882,00
	P. 62	<b>10101021</b>		358,00	467,00	609,00	1.019,00
	P. 35	<b>10101007</b>		272,00	347,00	440,00	693,00
L. 25	P. 46	<b>10101008</b>		321,00	414,00	537,00	882,00
	P. 51	<b>10101009</b>		321,00	414,00	537,00	882,00
	P. 62	<b>10101022</b>		358,00	467,00	609,00	1.019,00
L. 30	P. 35	<b>10101010</b>		294,00	387,00	490,00	770,00
	P. 46	<b>10101011</b>		347,00	459,00	592,00	964,00
	P. 51	<b>10101012</b>		347,00	459,00	592,00	964,00
L. 35	P. 62	<b>10101023</b>		393,00	521,00	672,00	1.109,00
	P. 35	<b>10101013</b>		294,00	387,00	490,00	770,00
	P. 46	<b>10101014</b>		347,00	459,00	592,00	964,00
L. 50	P. 51	<b>10101015</b>		347,00	459,00	592,00	964,00
	P. 62	<b>10101024</b>		393,00	521,00	672,00	1.109,00
	P. 35	<b>10101025</b>		332,00	451,00	571,00	890,00
L. 50	P. 46	<b>10101026</b>		392,00	529,00	679,00	1.091,00
	P. 51	<b>10101027</b>		392,00	529,00	679,00	1.091,00
	P. 62	<b>10101028</b>		435,00	587,00	754,00	1.233,00
L. 25	P. 35	<b>10103001</b>		425,00	499,00	593,00	850,00
	P. 46	<b>10103002</b>		475,00	570,00	692,00	1.041,00
	P. 51	<b>10103003</b>		475,00	570,00	692,00	1.041,00
L. 35	P. 62	<b>10103010</b>		515,00	621,00	763,00	1.178,00
	P. 35	<b>10103004</b>		458,00	549,00	654,00	937,00
	P. 46	<b>10103005</b>		513,00	622,00	756,00	1.131,00
L. 50	P. 51	<b>10103006</b>		513,00	622,00	756,00	1.131,00
	P. 62	<b>10103011</b>		559,00	682,00	836,00	1.278,00
	P. 35	<b>10103007</b>		505,00	621,00	743,00	1.065,00
L. 50	P. 46	<b>10103008</b>		570,00	706,00	855,00	1.270,00
	P. 51	<b>10103009</b>		570,00	706,00	855,00	1.270,00
	P. 62	<b>10103012</b>		614,00	762,00	933,00	1.413,00

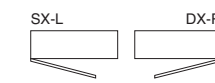
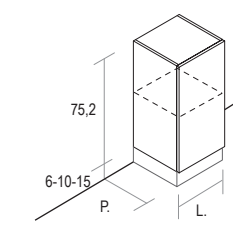

**BASE 1 CASSETTO H. 25**  
**1 ANTA DX-SX H. 50**  
BASE W/1 UPPER DRAWER AND 1 LOWER  
DOOR R-L

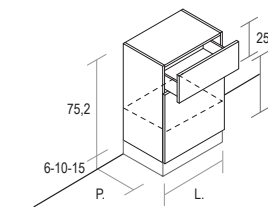

**ILLUMINAZIONE INTERNA DISPONIBILE SOLO PER CASSETTO**  
INTERNAL LIGHTING AVAILABLE ONLY FOR DRAWER

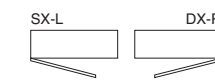

**FINITURE/FINISHES:**  
① NOBILITATO; ② LACCATO OPACO; ③ LACCATO LUCIDO; ④ LACCATO METALLO; ⑤ IMPIALLACCIATO; ⑥ HPL; ⑦ RESINA CEMENTO  
① MELAMINE; ② MATT LACQUERED; ③ GLOSSY LACQUERED; ④ METAL LACQUERED; ⑤ VENEREED WOOD; ⑥ HPL; ⑦ RESIN CEMENT

## AIRY SISTEMA | BASI SOSPESSE H. 75 / BASI A TERRA CON ZOCCOLO H. 6-10-15 O PIEDINI REGOLABILI

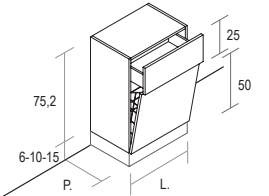
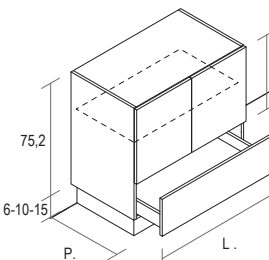
AIRY SISTEMA WALL HUNG BASES H. 75 FLOOR-STANDING BASES WITH 6-10-15 PLINTH OR ADJUSTABLE FEET		DIMENSIONI DIMENSIONS	CODICE CODE	①	②	③ ④ ⑤ ⑥	⑦		
<b>BASE 1 CASSETTO H. 25 1 ANTA RIBALTA H.50 CON CESTO PORTABIANCHERIA</b> 1-DRAWER + FLIP-DOWN DOOR BASE W/LAUNDRY BASKET		P. 35	<b>10719001</b>	532,00	622,00	728,00	1.013,00		
		P. 46	<b>10719002</b>	577,00	687,00	821,00	1.199,00		
		P. 51	<b>10719003</b>	577,00	687,00	821,00	1.199,00		
		P. 62	<b>10719007</b>	614,00	737,00	890,00	1.333,00		
<b>DIM. CESTO PORTABIANCHERIA H. 43 L. 27/40 P. 28</b> LAUNDRY BASKET DIMENSIONS H. 43 W. 27/40 D. 28		P. 35	<b>10719004</b>	609,00	721,00	844,00	1.166,00		
		P. 46	<b>10719005</b>	674,00	806,00	955,00	1.371,00		
		P. 51	<b>10719006</b>	674,00	806,00	955,00	1.371,00		
<b>! ATTENZIONE NON UTILIZZABILE CON GOLA G3</b> !ATTENTION DO NOT USE WITH G3 GROOVE	L. 50	P. 62	<b>10719008</b>	715,00	863,00	1.032,00	1.513,00		
		<b>BASE 2 ANTE H. 50 1 CASSETTO H. 25</b> BASE W/1 LOWER DRAWER AND 2 UPPER DOORS		P. 35	<b>10138001</b>	675,00	801,00	934,00	1.278,00
				P. 46	<b>10138002</b>	743,00	888,00	1.048,00	1.486,00
P. 51	<b>10138003</b>			743,00	888,00	1.048,00	1.486,00		
P. 62	<b>10138004</b>			791,00	950,00	1.133,00	1.635,00		
	L. 70	P. 35	<b>10138005</b>	701,00	843,00	986,00	1.355,00		
		P. 46	<b>10138006</b>	784,00	944,00	1.118,00	1.579,00		
		P. 51	<b>10138007</b>	784,00	944,00	1.118,00	1.579,00		
	L. 85	P. 62	<b>10138008</b>	838,00	1.013,00	1.205,00	1.732,00		
		P. 35	<b>10138009</b>	770,00	936,00	1.096,00	1.502,00		
		P. 46	<b>10138010</b>	859,00	1.043,00	1.232,00	1.732,00		
	L. 95	P. 51	<b>10138011</b>	859,00	1.043,00	1.232,00	1.732,00		
		P. 62	<b>10138012</b>	896,00	1.095,00	1.303,00	1.868,00		
		P. 35	<b>10138013</b>	823,00	1.005,00	1.176,00	1.609,00		
	L. 105	P. 46	<b>10138014</b>	917,00	1.119,00	1.318,00	1.843,00		
		P. 51	<b>10138015</b>	917,00	1.119,00	1.318,00	1.843,00		
		P. 62	<b>10138016</b>	977,00	1.193,00	1.412,00	2.004,00		
	L. 105	P. 35	<b>10138017</b>	854,00	1.046,00	1.224,00	1.674,00		
		P. 46	<b>10138018</b>	955,00	1.173,00	1.384,00	1.934,00		
		P. 51	<b>10138019</b>	955,00	1.173,00	1.384,00	1.934,00		
		P. 62	<b>10138020</b>	1.021,00	1.253,00	1.482,00	2.098,00		

## FINITURE/FINISHES:

① NOBILITATO; ② LACCATO OPACO; ③ LACCATO LUCIDO; ④ LACCATO METALLO; ⑤ IMPIALLACCIATO; ⑥ HPL; ⑦ RESINA CEMENTO  
① MELAMINE; ② MATT LACQUERED; ③ GLOSSY LACQUERED; ④ METAL LACQUERED; ⑤ VENEREED WOOD; ⑥ HPL; ⑦ RESIN CEMENT

## AIRY SISTEMA | BASI SOSPESSE H. 75 / BASI A TERRA CON ZOCCOLO H. 6-10-15 O PIEDINI REGOLABILI

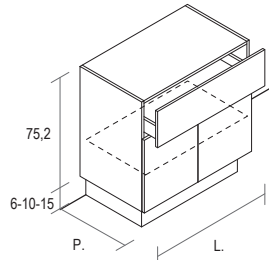
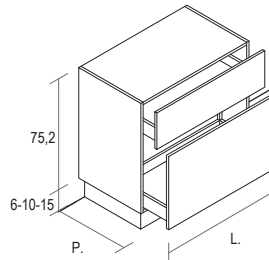
AIRY SISTEMA WALL HUNG BASES H. 75 FLOOR-STANDING BASES WITH 6-10-15 PLINTH OR ADJUSTABLE FEET		DIMENSIONI DIMENSIONS	CODICE CODE	①	②	③ ④ ⑤ ⑥	⑦
<b>BASE 1 CASSETTO H. 25 2 ANTE H. 50</b> BASE W/1 UPPER DRAWER AND 2 LOWER DOORS		P. 35	<b>10139001</b>	573,00	701,00	836,00	1.178,00
		P. 46	<b>10139002</b>	630,00	778,00	941,00	1.376,00
		P. 51	<b>10139003</b>	630,00	778,00	941,00	1.376,00
		P. 62	<b>10139004</b>	675,00	836,00	1.018,00	1.521,00
	L. 60	P. 35	<b>10139005</b>	592,00	736,00	881,00	1.250,00
		P. 46	<b>10139006</b>	666,00	832,00	1.004,00	1.467,00
		P. 51	<b>10139007</b>	666,00	832,00	1.004,00	1.467,00
	L. 70	P. 62	<b>10139008</b>	717,00	894,00	1.087,00	1.615,00
		P. 35	<b>10139009</b>	652,00	819,00	982,00	1.390,00
		P. 46	<b>10139010</b>	730,00	918,00	1.109,00	1.610,00
	L. 85	P. 51	<b>10139011</b>	730,00	918,00	1.109,00	1.610,00
		P. 62	<b>10139012</b>	783,00	985,00	1.194,00	1.762,00
		P. 35	<b>10139013</b>	695,00	879,00	1.053,00	1.485,00
	L. 95	P. 46	<b>10139014</b>	778,00	982,00	1.184,00	1.710,00
		P. 51	<b>10139015</b>	778,00	982,00	1.184,00	1.710,00
		P. 62	<b>10139016</b>	823,00	1.041,00	1.262,00	1.855,00
	L. 105	P. 35	<b>10139017</b>	723,00	918,00	1.098,00	1.549,00
		P. 46	<b>10139018</b>	813,00	1.034,00	1.247,00	1.799,00
		P. 51	<b>10139019</b>	813,00	1.034,00	1.247,00	1.799,00
		P. 62	<b>10139020</b>	871,00	1.105,00	1.336,00	1.955,00
<b>BASE 1 CASSETTO H. 25 1 CASSETTO H. 50</b> BASE W/1 UPPER DRAWER H. 25 AND 1 LOWER DRAWER H. 50		P. 35	<b>10140001</b>	665,00	799,00	932,00	1.284,00
		P. 46	<b>10140002</b>	728,00	881,00	1.042,00	1.488,00
		P. 51	<b>10140003</b>	728,00	881,00	1.042,00	1.488,00
		P. 62	<b>10140004</b>	774,00	939,00	1.122,00	1.632,00
	L. 60	P. 35	<b>10140005</b>	686,00	836,00	980,00	1.359,00
		P. 46	<b>10140006</b>	769,00	939,00	1.111,00	1.583,00
		P. 51	<b>10140007</b>	769,00	939,00	1.111,00	1.583,00
	L. 70	P. 62	<b>10140008</b>	818,00	1.002,00	1.194,00	1.732,00
		P. 35	<b>10140009</b>	751,00	927,00	1.087,00	1.506,00
		P. 46	<b>10140010</b>	839,00	1.034,00	1.223,00	1.735,00
	L. 85	P. 51	<b>10140011</b>	839,00	1.034,00	1.223,00	1.735,00
		P. 62	<b>10140012</b>	889,00	1.100,00	1.309,00	1.887,00
		P. 35	<b>10140013</b>	796,00	989,00	1.161,00	1.606,00
	L. 95	P. 46	<b>10140014</b>	889,00	1.102,00	1.302,00	1.840,00
		P. 51	<b>10140015</b>	889,00	1.102,00	1.302,00	1.840,00
		P. 62	<b>10140016</b>	934,00	1.161,00	1.381,00	1.986,00
	L. 105	P. 35	<b>10140017</b>	827,00	1.037,00	1.221,00	1.692,00
		P. 46	<b>10140018</b>	923,00	1.154,00	1.364,00	1.930,00
		P. 51	<b>10140019</b>	923,00	1.154,00	1.364,00	1.930,00
		P. 62	<b>10140020</b>	981,00	1.226,00	1.456,00	2.087,00

## FINITURE/FINISHES:

① NOBILITATO; ② LACCATO OPACO; ③ LACCATO LUCIDO; ④ LACCATO METALLO; ⑤ IMPIALLACCIATO; ⑥ HPL; ⑦ RESINA CEMENTO  
① MELAMINE; ② MATT LACQUERED; ③ GLOSSY LACQUERED; ④ METAL LACQUERED; ⑤ VENEREED WOOD; ⑥ HPL; ⑦ RESIN CEMENT

**AIRY SISTEMA | BASI SOSPESSE H. 75 / BASI A TERRA CON ZOCCOLO H. 6-10-15 O PIEDINI REGOLABILI**

AIRY SISTEMA  
WALL HUNG BASES H. 75  
FLOOR-STANDING BASES WITH 6-10-15  
PLINTH OR ADJUSTABLE FEET

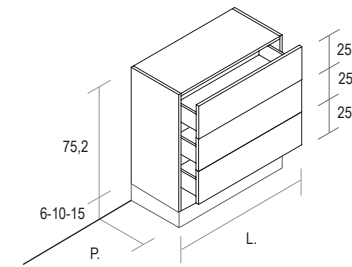
**BASE 3 CASSETTI**  
BASE W/3 DRAWERS

 **ILLUMINAZIONE INTERNA DISPONIBILE**  
INTERNAL LIGHTING AVAILABLE

DIMENSIONI DIMENSIONS	CODICE CODE	①	②	③ ④ ⑤ ⑥	⑦	
L. 35	P. 35	<b>10111030</b>	743,00	831,00	934,00	1.221,00
	P. 46	<b>10111010</b>	796,00	903,00	1.036,00	1.415,00
	P. 51	<b>10111011</b>	796,00	903,00	1.036,00	1.415,00
	P. 62	<b>10111012</b>	810,00	915,00	1.048,00	1.428,00
L. 50	P. 35	<b>10111031</b>	802,00	911,00	1.033,00	1.359,00
	P. 46	<b>10111013</b>	867,00	996,00	1.145,00	1.564,00
	P. 51	<b>10111014</b>	867,00	996,00	1.145,00	1.564,00
	P. 62	<b>10111015</b>	881,00	1.009,00	1.161,00	1.578,00
L. 60	P. 35	<b>10111032</b>	848,00	975,00	1.106,00	1.455,00
	P. 46	<b>10111001</b>	922,00	1.068,00	1.229,00	1.671,00
	P. 51	<b>10111002</b>	922,00	1.068,00	1.229,00	1.671,00
	P. 62	<b>10111016</b>	964,00	1.122,00	1.303,00	1.811,00
L. 70	P. 35	<b>10111033</b>	882,00	1.024,00	1.170,00	1.548,00
	P. 46	<b>10111003</b>	960,00	1.123,00	1.297,00	1.768,00
	P. 51	<b>10111004</b>	960,00	1.123,00	1.297,00	1.768,00
	P. 62	<b>10111017</b>	1.002,00	1.178,00	1.373,00	1.909,00
L. 85	P. 35	<b>10111034</b>	945,00	1.111,00	1.273,00	1.689,00
	P. 46	<b>10111005</b>	1.030,00	1.217,00	1.408,00	1.917,00
	P. 51	<b>10111006</b>	1.030,00	1.217,00	1.408,00	1.917,00
	P. 62	<b>10111018</b>	1.073,00	1.273,00	1.484,00	2.060,00
L. 95	P. 35	<b>10111035</b>	997,00	1.179,00	1.353,00	1.797,00
	P. 46	<b>10111019</b>	1.087,00	1.291,00	1.491,00	2.029,00
	P. 51	<b>10111020</b>	1.087,00	1.291,00	1.491,00	2.029,00
	P. 62	<b>10111021</b>	1.128,00	1.346,00	1.567,00	2.169,00
L. 105	P. 35	<b>10111036</b>	1.031,00	1.233,00	1.416,00	1.883,00
	P. 46	<b>10111007</b>	1.123,00	1.343,00	1.555,00	2.117,00
	P. 51	<b>10111008</b>	1.123,00	1.343,00	1.555,00	2.117,00
	P. 62	<b>10111022</b>	1.168,00	1.403,00	1.636,00	2.264,00

## AIRY SISTEMA BASI A TERRA H. 87 CON PIEDINO REGOLABILE COMPRESO H. 2 CM

AIRY SISTEMA  
FLOOR-STANDING BASES H. 87  
WITH H.2 CM ADJUSTABLE FEET INCLUDED

**FINITURE/FINISHES:**

① NOBILITATO; ② LACCATO OPACO; ③ LACCATO LUCIDO; ④ LACCATO METALLO; ⑤ IMPIALLACCIATO; ⑥ HPL; ⑦ RESINA CEMENTO  
① MELAMINE; ② MATT LACQUERED; ③ GLOSSY LACQUERED; ④ METAL LACQUERED; ⑤ VENEREED WOOD; ⑥ HPL; ⑦ RESIN CEMENT

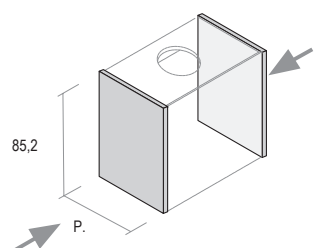
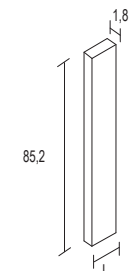

**AIRY SISTEMA | ACCESSORI PER BASI A TERRA H. 87 CON PIEDINI REGOLABILI - OPZIONALI**

AIRY SISTEMA ACCESSORIES FOR BASES H. 87		DIMENSIONI DIMENSIONS	CODICE CODE	①	②	③ ④ ⑤ ⑥	⑦
<b>FIANCO DI FINITURA SP. 1,2</b> ADDITIONAL FINISHING SIDE-PANEL TH. 1.2 	P. 35	H. 85	<b>19000050</b>	102,00	172,00	190,00	403,00
	P. 46		<b>19000051</b>	125,00	185,00	215,00	519,00
	P. 51		<b>19000052</b>	125,00	185,00	215,00	519,00
	P. 62		<b>19000053</b>	130,00	195,00	250,00	672,00
<b>FASCIA DI TAMPONAMENTO PER BASE H. 85</b> FILLER WOODEN-STRIP FOR BASES H.85 		H. 85 L. 5 - 15	<b>19126010</b>	106,00	158,00	173,00	279,00

**N.B. I PREZZI SI RIFERISCONO AD UN SINGOLO FIANCO**  
 N.B. : THE PRICES REFER TO A SINGLE SIDE

**N.B. MISURA MINIMA L. 5 CM E MASSIMA L. 15 CM**  
 N.B. MIN. L. 5 CM AND MAX L. 15 CM

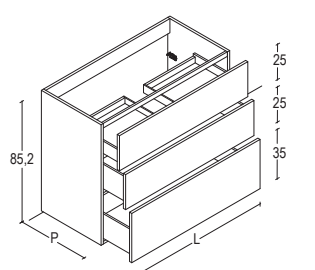
**AIRY SISTEMA | BASI A TERRA H. 87 CON PIEDINI REGOLABILI (BASE H.85 + PIEDINI H.2 CM)**

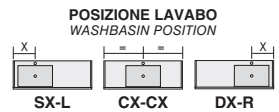
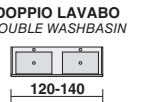
AIRY SISTEMA FLOOR-STANDING BASES WITH INCLUDED ADJUSTABLE FEET H. 87		DIMENSIONI DIMENSIONS	CODICE CODE	①	②	③ ④ ⑤ ⑥	⑦
<b>BASE LAVABO 2 CASSETTI H. 25 E 1 CASSETTO H. 35</b> WASHBASIN BASE W/3 DRAWERS (25+25+35) 	P. 35	L. 60	<b>10446001</b>	971,00	1.097,00	1.229,00	1.583,00
	P. 46		<b>10446002</b>	1.045,00	1.190,00	1.352,00	1.799,00
	P. 51		<b>10446003</b>	1.045,00	1.190,00	1.352,00	1.799,00
	P. 62		<b>10446004</b>	1.086,00	1.245,00	1.425,00	1.937,00
 <b>ILLUMINAZIONE INTERNA DISPONIBILE</b> INTERNAL LIGHTING AVAILABLE	P. 35	L. 70	<b>10446005</b>	1.001,00	1.141,00	1.286,00	1.664,00
	P. 46		<b>10446006</b>	1.079,00	1.240,00	1.413,00	1.884,00
	P. 51		<b>10446007</b>	1.079,00	1.240,00	1.413,00	1.884,00
	P. 62		<b>10446008</b>	1.122,00	1.295,00	1.488,00	2.025,00
<b>POSIZIONE LAVABO WASHBASIN POSITION</b> 	P. 35	L. 85	<b>10446009</b>	1.089,00	1.253,00	1.413,00	1.830,00
	P. 46		<b>10446010</b>	1.174,00	1.359,00	1.548,00	2.058,00
	P. 51		<b>10446011</b>	1.174,00	1.359,00	1.548,00	2.058,00
<b>DOPPIO LAVABO DOUBLE WASHBASIN</b> 	P. 62	L. 95	<b>10446012</b>	1.218,00	1.417,00	1.626,00	2.201,00
	P. 35		<b>10446013</b>	1.152,00	1.332,00	1.504,00	1.947,00
	P. 46	L. 105	<b>10446014</b>	1.242,00	1.444,00	1.642,00	2.179,00
	P. 51		<b>10446015</b>	1.242,00	1.444,00	1.642,00	2.179,00
	P. 62		<b>10446016</b>	1.280,00	1.494,00	1.713,00	2.314,00
	P. 35	L. 120	<b>10446017</b>	1.189,00	1.386,00	1.568,00	2.035,00
	P. 46		<b>10446018</b>	1.281,00	1.496,00	1.707,00	2.269,00
	P. 51		<b>10446019</b>	1.281,00	1.496,00	1.707,00	2.269,00
	P. 62		<b>10446020</b>	1.326,00	1.556,00	1.788,00	2.413,00
	P. 35	L. 140	<b>10446021</b>	1.260,00	1.482,00	1.680,00	2.185,00
	P. 46		<b>10446022</b>	1.359,00	1.600,00	1.827,00	2.426,00
	P. 51		<b>10446023</b>	1.359,00	1.600,00	1.827,00	2.426,00
	P. 62	L. 140	<b>10446024</b>	1.408,00	1.663,00	1.909,00	2.573,00
	P. 35		<b>10446025</b>	1.377,00	1.631,00	1.851,00	2.407,00
	P. 46		<b>10446026</b>	1.464,00	1.737,00	1.986,00	2.636,00
	P. 51	L. 140	<b>10446027</b>	1.464,00	1.737,00	1.986,00	2.636,00
	P. 62		<b>10446028</b>	1.517,00	1.803,00	2.072,00	2.788,00

**FINITURE/FINISHES:**  
 ① NOBILITATO; ② LACCATO OPACO; ③ LACCATO LUCIDO; ④ LACCATO METALLO; ⑤ IMPIALLACCIATO; ⑥ HPL; ⑦ RESINA CEMENTO  
 ① MELAMINE; ② MATT LACQUERED; ③ GLOSSY LACQUERED; ④ METAL LACQUERED; ⑤ VENEREED WOOD; ⑥ HPL; ⑦ RESIN CEMENT

**FINITURE/FINISHES:**  
 ① NOBILITATO; ② LACCATO OPACO; ③ LACCATO LUCIDO; ④ LACCATO METALLO; ⑤ IMPIALLACCIATO; ⑥ HPL; ⑦ RESINA CEMENTO  
 ① MELAMINE; ② MATT LACQUERED; ③ GLOSSY LACQUERED; ④ METAL LACQUERED; ⑤ VENEREED WOOD; ⑥ HPL; ⑦ RESIN CEMENT

**AIRY SISTEMA | BASI A TERRA H. 87 CON PIEDINI REGOLABILI (BASE H.85 + PIEDINI H.2 CM)**

AIRY SISTEMA  
FLOOR-STANDING BASES WITH  
INCLUDED ADJUSTABLE FEET H. 87

**BASE LAVABO 1 CASSETTO H. 35  
E 1 CASSETTO H. 50**  
WASHBASIN BASE W/2 DRAWERS (35+50)

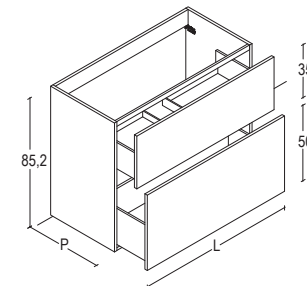

**ILLUMINAZIONE INTERNA  
DISPONIBILE**  
INTERNAL LIGHTING AVAILABLE

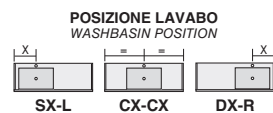

DIMENSIONI DIMENSIONS	CODICE CODE	①	②	③ ④ ⑤ ⑥	⑦	
L. 60	P. 35	<b>10434001</b>	714,00	848,00	981,00	1.335,00
	P. 46	<b>10434002</b>	780,00	933,00	1.095,00	1.542,00
	P. 51	<b>10434003</b>	780,00	933,00	1.095,00	1.542,00
	P. 62	<b>10434004</b>	821,00	986,00	1.168,00	1.681,00
L. 70	P. 35	<b>10434005</b>	739,00	888,00	1.032,00	1.413,00
	P. 46	<b>10434006</b>	811,00	980,00	1.152,00	1.626,00
	P. 51	<b>10434007</b>	811,00	980,00	1.152,00	1.626,00
	P. 62	<b>10434008</b>	851,00	1.035,00	1.227,00	1.767,00
L. 85	P. 35	<b>10434009</b>	808,00	983,00	1.145,00	1.566,00
	P. 46	<b>10434010</b>	887,00	1.081,00	1.270,00	1.785,00
	P. 51	<b>10434011</b>	887,00	1.081,00	1.270,00	1.785,00
	P. 62	<b>10434012</b>	931,00	1.139,00	1.348,00	1.928,00
L. 95	P. 35	<b>10434013</b>	854,00	1.046,00	1.218,00	1.665,00
	P. 46	<b>10434014</b>	936,00	1.149,00	1.347,00	1.888,00
	P. 51	<b>10434015</b>	936,00	1.149,00	1.347,00	1.888,00
	P. 62	<b>10434016</b>	980,00	1.206,00	1.425,00	2.032,00
L. 105	P. 35	<b>10434017</b>	887,00	1.097,00	1.280,00	1.753,00
	P. 46	<b>10434018</b>	959,00	1.189,00	1.398,00	1.966,00
	P. 51	<b>10434019</b>	959,00	1.189,00	1.398,00	1.966,00
	P. 62	<b>10434020</b>	1.005,00	1.249,00	1.479,00	2.112,00

**AIRY SISTEMA | BASI A TERRA H. 87 CON PIEDINI REGOLABILI (BASE H.85 + PIEDINI H.2 CM)**

AIRY SISTEMA  
FLOOR-STANDING BASES WITH  
INCLUDED ADJUSTABLE FEET H. 87

**BASE 2 CASSETTI  
H. 25 E 1 CASSETTO H. 35**  
BASE W/3 DRAWERS (25+25+35)

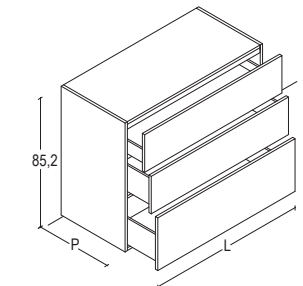

**ILLUMINAZIONE INTERNA  
DISPONIBILE**  
INTERNAL LIGHTING AVAILABLE

DIMENSIONI DIMENSIONS	CODICE CODE	①	②	③ ④ ⑤ ⑥	⑦	
L. 35	P. 35	<b>10146001</b>	743,00	831,00	934,00	1.221,00
	P. 46	<b>10146002</b>	796,00	903,00	1.036,00	1.415,00
	P. 51	<b>10146003</b>	796,00	903,00	1.036,00	1.415,00
	P. 62	<b>10146004</b>	810,00	915,00	1.048,00	1.428,00
L. 50	P. 35	<b>10146005</b>	802,00	911,00	1.033,00	1.359,00
	P. 46	<b>10146006</b>	867,00	996,00	1.145,00	1.564,00
	P. 51	<b>10146007</b>	867,00	996,00	1.145,00	1.564,00
	P. 62	<b>10146008</b>	881,00	1.009,00	1.161,00	1.578,00
L. 60	P. 35	<b>10146009</b>	848,00	975,00	1.106,00	1.455,00
	P. 46	<b>10146010</b>	922,00	1.068,00	1.229,00	1.671,00
	P. 51	<b>10146011</b>	922,00	1.068,00	1.229,00	1.671,00
	P. 62	<b>10146012</b>	964,00	1.122,00	1.303,00	1.811,00
L. 70	P. 35	<b>10146013</b>	882,00	1.024,00	1.170,00	1.548,00
	P. 46	<b>10146014</b>	960,00	1.123,00	1.297,00	1.768,00
	P. 51	<b>10146015</b>	960,00	1.123,00	1.297,00	1.768,00
	P. 62	<b>10146016</b>	1.002,00	1.178,00	1.373,00	1.909,00
L. 85	P. 35	<b>10146017</b>	945,00	1.111,00	1.273,00	1.689,00
	P. 46	<b>10146018</b>	1.030,00	1.217,00	1.408,00	1.917,00
	P. 51	<b>10146019</b>	1.030,00	1.217,00	1.408,00	1.917,00
	P. 62	<b>10146020</b>	1.073,00	1.273,00	1.484,00	2.060,00
L. 95	P. 35	<b>10146021</b>	997,00	1.179,00	1.353,00	1.797,00
	P. 46	<b>10146022</b>	1.087,00	1.291,00	1.491,00	2.029,00
	P. 51	<b>10146023</b>	1.087,00	1.291,00	1.491,00	2.029,00
	P. 62	<b>10146024</b>	1.128,00	1.346,00	1.567,00	2.169,00
L. 105	P. 35	<b>10146025</b>	1.031,00	1.233,00	1.416,00	1.883,00
	P. 46	<b>10146026</b>	1.123,00	1.343,00	1.555,00	2.117,00
	P. 51	<b>10146027</b>	1.123,00	1.343,00	1.555,00	2.117,00
	P. 62	<b>10146028</b>	1.168,00	1.403,00	1.636,00	2.264,00

**FINITURE/FINISHES:**

① NOBILITATO; ② LACCATO OPACO; ③ LACCATO LUCIDO; ④ LACCATO METALLO; ⑤ IMPIALLACCIATO; ⑥ HPL; ⑦ RESINA CEMENTO  
① MELAMINE; ② MATT LACQUERED; ③ GLOSSY LACQUERED; ④ METAL LACQUERED; ⑤ VENEREED WOOD; ⑥ HPL; ⑦ RESIN CEMENT

**FINITURE/FINISHES:**

① NOBILITATO; ② LACCATO OPACO; ③ LACCATO LUCIDO; ④ LACCATO METALLO; ⑤ IMPIALLACCIATO; ⑥ HPL; ⑦ RESINA CEMENTO  
① MELAMINE; ② MATT LACQUERED; ③ GLOSSY LACQUERED; ④ METAL LACQUERED; ⑤ VENEREED WOOD; ⑥ HPL; ⑦ RESIN CEMENT

**AIRY SISTEMA | BASI A TERRA H. 87 CON PIEDINI REGOLABILI (BASE H.85 + PIEDINI H.2 CM)**

AIRY SISTEMA  
FLOOR-STANDING BASES WITH  
INCLUDED ADJUSTABLE FEET H. 87

**BASE 1 CASSETTO H. 35**  
**1 CASSETTO H. 50**  
BASE W/2 DRAWERS (35+50)

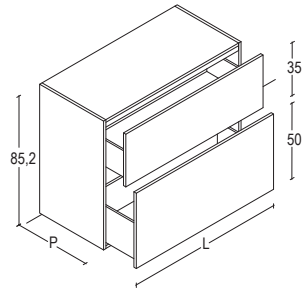

 **ILLUMINAZIONE INTERNA  
DISPONIBILE**  
INTERNAL LIGHTING AVAILABLE

DIMENSIONI DIMENSIONS	CODICE CODE	①	②	③ ④ ⑤ ⑥	⑦	
L. 60	P. 35	<b>10134001</b>	665,00	799,00	932,00	1.284,00
	P. 46	<b>10134002</b>	728,00	881,00	1.042,00	1.488,00
	P. 51	<b>10134003</b>	728,00	881,00	1.042,00	1.488,00
	P. 62	<b>10134004</b>	774,00	939,00	1.122,00	1.632,00
L. 70	P. 35	<b>10134005</b>	686,00	836,00	980,00	1.359,00
	P. 46	<b>10134006</b>	769,00	939,00	1.111,00	1.583,00
	P. 51	<b>10134007</b>	769,00	939,00	1.111,00	1.583,00
	P. 62	<b>10134008</b>	818,00	1.002,00	1.194,00	1.732,00
L. 85	P. 35	<b>10134009</b>	751,00	927,00	1.087,00	1.506,00
	P. 46	<b>10134010</b>	839,00	1.034,00	1.223,00	1.735,00
	P. 51	<b>10134011</b>	839,00	1.034,00	1.223,00	1.735,00
	P. 62	<b>10134012</b>	889,00	1.100,00	1.309,00	1.887,00
L. 95	P. 35	<b>10134013</b>	796,00	989,00	1.161,00	1.606,00
	P. 46	<b>10134014</b>	889,00	1.102,00	1.302,00	1.840,00
	P. 51	<b>10134015</b>	889,00	1.102,00	1.302,00	1.840,00
	P. 62	<b>10134016</b>	934,00	1.161,00	1.381,00	1.986,00
L. 105	P. 35	<b>10134017</b>	827,00	1.037,00	1.221,00	1.692,00
	P. 46	<b>10134018</b>	923,00	1.154,00	1.364,00	1.930,00
	P. 51	<b>10134019</b>	923,00	1.154,00	1.364,00	1.930,00
	P. 62	<b>10134020</b>	981,00	1.226,00	1.456,00	2.087,00

## AIRY SISTEMA PENSILI E COLONNE

AIRY SISTEMA  
CUPBOARDS AND COLUMNS

**FINITURE/FINISHES:**

① NOBILITATO; ② LACCATO OPACO; ③ LACCATO LUCIDO; ④ LACCATO METALLO; ⑤ IMPIALLACCIATO; ⑥ HPL; ⑦ RESINA CEMENTO  
① MELAMINE; ② MATT LACQUERED; ③ GLOSSY LACQUERED; ④ METAL LACQUERED; ⑤ VENEREED WOOD; ⑥ HPL; ⑦ RESIN CEMENT

**AIRY SISTEMA | ILLUMINAZIONE INTERNA 1 LATO PER PENSILI E COLONNE - OPZIONALE**

AIRY SISTEMA 1-SIDE INTERNAL LIGHTING FOR CUPBOARDS AND COLUMNS	DIMENSIONI DIMENSIONS	LUMEN LUMEN	CODICE CODE	PREZZO PRICE
<b>ILLUMINAZIONE INTERNA CON 1 STRIP LED VERTICALE DX E CON SENSORE DI APERTURA E ALIMENTATORE</b> <i>INTERNAL LIGHTING W/1 VERTICAL LED STRIP (RIGHT SIDE) OPENING SENSOR AND POWER SUPPLY</i>	H. 35	585	<b>91515010</b>	184,00
	H. 50	835	<b>91515011</b>	184,00
	H. 70	1169	<b>91515012</b>	194,00
	H. 80	1336	<b>91515013</b>	197,00
	H. 100	1670	<b>91515014</b>	208,00
	H. 150	2505	<b>91515015</b>	237,00
	H. 170	2839	<b>91515016</b>	247,00
	H. 205	3424	<b>91515017</b>	278,00

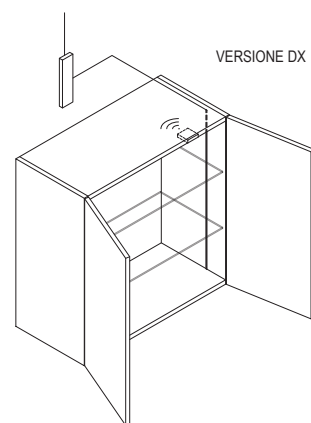

**ILLUMINAZIONE INTERNA  
DISPONIBILE**  
*INTERNAL LIGHTING AVAILABLE*

**!ATTENZIONE**  
**LO STRIP LED VIENE POSIZIONATO DI SERIE SUL FIANCO DX. E' POSSIBILE RICHIEDERNE IL POSIZIONAMENTO SUL FIANCO SX.**  
*!ATTENTION*  
*THE LED STRIP IS POSITIONED ON THE RIGHT SIDE AS STANDARD. IT IS POSSIBLE TO REQUEST ITS POSITIONING ON THE LEFT SIDE.*

**AIRY SISTEMA | ILLUMINAZIONE INTERNA 2 LATI PER PENSILI E COLONNE - OPZIONALE**

AIRY SISTEMA 2- SIDES INTERNAL LIGHTING FOR CUPBOARDS AND COLUMNS	DIMENSIONI DIMENSIONS	LUMEN LUMEN	CODICE CODE	PREZZO PRICE
<b>ILLUMINAZIONE INTERNA CON 2 STRIP LED VERTICALE DX E SX E CON SENSORE DI APERTURA E ALIMENTATORE</b> <i>INTERNAL LIGHTING W/2 VERTICAL LED STRIPS OPENING SENSOR AND POWER SUPPLY</i>	H. 35	1170	<b>91515023</b>	236,00
	H. 50	1670	<b>91515024</b>	236,00
	H. 70	2338	<b>91515025</b>	256,00
	H. 80	2672	<b>91515026</b>	262,00
	H. 100	3340	<b>91515027</b>	284,00
	H. 150	5010	<b>91515028</b>	338,00
	H. 170	5678	<b>91515029</b>	358,00
	H. 205	6848	<b>91515030</b>	406,00

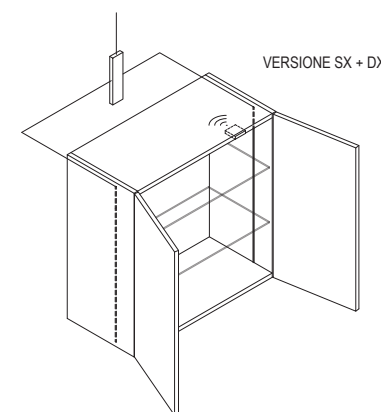

**ILLUMINAZIONE INTERNA  
DISPONIBILE**  
*INTERNAL LIGHTING AVAILABLE*

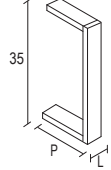
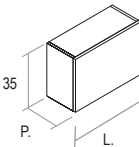
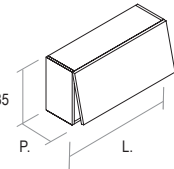
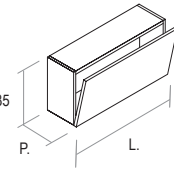

**AIRY SISTEMA | PENSILI H. 35 - SPECIFICARE IL SENSO DI APERTURA**

AIRY SISTEMA WALL UNITS H. 35 SPECIFY OPENING DIRECTION	DIMENSIONI DIMENSIONS	CODICE CODE	①	②	③	④	⑤	⑥	⑦
<b>TAMPONAMENTO PENSILE H. 35</b> FILLER WOODEN-STRIP FOR FOR WALL UNITS 	P. 16	<b>19126011</b>	94,00	141,00	155,00				
	L. 5 - 15 P. 22	<b>19126012</b>	111,00	166,00	182,00				
	P. 35	<b>19126013</b>	139,00	208,00	228,00				
<b>PENSILE 1 ANTA</b> CUPBOARD W/1 DOOR  SX-L DX-R	P. 16	<b>16001001</b>	144,00	177,00	223,00				
	L. 35 P. 22	<b>16001002</b>	157,00	198,00	253,00				
	P. 35	<b>16001003</b>	187,00	242,00	318,00				
	P. 16	<b>16001004</b>	165,00	211,00	273,00				
	L. 50 P. 22	<b>16001005</b>	180,00	236,00	309,00				
	P. 35	<b>16001006</b>	215,00	289,00	387,00				
<b>PENSILE 1 ANTA RIALZA</b> CUPBOARD W/1 FLIP-UP DOOR 	L. 50 P. 22	<b>16005001</b>	227,00	280,00	353,00				
	P. 35	<b>16005002</b>	262,00	333,00	430,00				
	L. 60 P. 22	<b>16005003</b>	240,00	305,00	390,00				
	P. 35	<b>16005004</b>	280,00	365,00	474,00				
	L. 70 P. 22	<b>16005005</b>	255,00	332,00	425,00				
	P. 35	<b>16005006</b>	298,00	397,00	521,00				
	L. 85 P. 22	<b>16005007</b>	277,00	370,00	480,00				
	P. 35	<b>16005008</b>	326,00	444,00	588,00				
	L. 105 P. 22	<b>16005009</b>	358,00	463,00	584,00				
	P. 35	<b>16005010</b>	431,00	573,00	746,00				
<b>PENSILE 1 ANTA RIBALTA</b> CUPBOARD W/1 FLIP-DOWN DOOR 	L. 50 P. 22	<b>16004001</b>	227,00	280,00	353,00				
	P. 35	<b>16004002</b>	262,00	333,00	430,00				
	L. 60 P. 22	<b>16004003</b>	240,00	305,00	390,00				
	P. 35	<b>16004004</b>	280,00	365,00	474,00				
	L. 70 P. 22	<b>16004005</b>	255,00	332,00	425,00				
	P. 35	<b>16004006</b>	298,00	397,00	521,00				
	L. 85 P. 22	<b>16004007</b>	277,00	370,00	480,00				
	P. 35	<b>16004008</b>	326,00	444,00	588,00				
	L. 105 P. 22	<b>16004009</b>	358,00	463,00	584,00				
	P. 35	<b>16004010</b>	431,00	573,00	746,00				

**FINITURE/FINISHES:**  
 ① NOBILITATO; ② LACCATO OPACO; ③ LACCATO LUCIDO; ④ LACCATO METALLO; ⑤ IMPIALLACCIATO; ⑥ HPL; ⑦ RESINA CEMENTO  
 ① MELAMINE; ② MATT LACQUERED; ③ GLOSSY LACQUERED; ④ METAL LACQUERED; ⑤ VENEREED WOOD; ⑥ HPL; ⑦ RESIN CEMENT

**AIRY SISTEMA | ELEMENTI A GIORNO H. 35 IN LEGNO SP. 1,2**

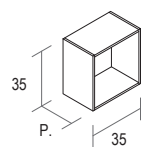
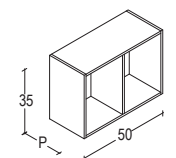
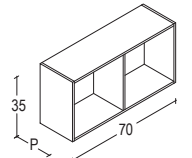
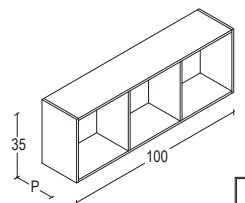
AIRY SISTEMA OPEN WOOD ELEMENTS TH. 1.2	DIMENSIONI DIMENSIONS	CODICE CODE	①	②	③	④	⑤	⑥	⑦
<b>ELEMENTO A GIORNO 35X35</b> OPEN CABINET 	P. 22	<b>17147020</b>	113,00	253,00	303,00				-
	P. 35	<b>17147021</b>	136,00	331,00	397,00				-
	P. 22	<b>17147023</b>	144,00	327,00	397,00				-
<b>ELEMENTO A GIORNO 35X50</b> OPEN CABINET 	P. 22	<b>17147024</b>	176,00	402,00	529,00				-
	P. 35	<b>17147025</b>	169,00	382,00	472,00				-
<b>ELEMENTO A GIORNO 35X70</b> OPEN CABINET 	P. 22	<b>17147026</b>	205,00	516,00	633,00				-
	P. 35	<b>17147027</b>	216,00	496,00	622,00				-
<b>ELEMENTO A GIORNO 35X100</b> OPEN CABINET 	P. 22	<b>17147028</b>	270,00	680,00	859,00				-
	P. 35	<b>17147028</b>	270,00	680,00	859,00				-

**FINITURE/FINISHES:**  
 ① NOBILITATO; ② LACCATO OPACO; ③ LACCATO LUCIDO; ④ LACCATO METALLO; ⑤ IMPIALLACCIATO; ⑥ HPL; ⑦ RESINA CEMENTO  
 ① MELAMINE; ② MATT LACQUERED; ③ GLOSSY LACQUERED; ④ METAL LACQUERED; ⑤ VENEREED WOOD; ⑥ HPL; ⑦ RESIN CEMENT

**AIRY SISTEMA | ELEMENTI A GIORNO H.35 IN METALLO LACC. BIANCO SP. 0,2 CON SCHIENA IN LEGNO**

AIRY SISTEMA  
LACQUERED METAL OPEN CABINETS (WHITE 0.2  
THICK METAL WITH WOODEN BACKS)

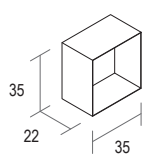
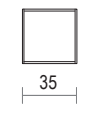
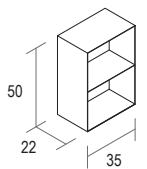
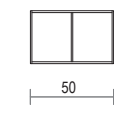
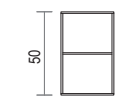
	DIMENSIONI DIMENSIONS	CODICE CODE	①	②	③ ④ ⑤ ⑥	⑦
<b>ELEMENTO A GIORNO 35X35</b> OPEN CABINET	 	P. 22 <b>17217001</b>	302,00	315,00	324,00	380,00
<b>ELEMENTO A GIORNO 50X35 REVERSIBILE</b> REVERSIBLE OPEN CABINET	  	P. 22 <b>17217007</b>	355,00	373,00	389,00	462,00

**FINITURE/FINISHES:**

① NOBILITATO; ② LACCATO OPACO; ③ LACCATO LUCIDO; ④ LACCATO METALLO; ⑤ IMPIALLACCIATO; ⑥ HPL; ⑦ RESINA CEMENTO  
① MELAMINE; ② MATT LACQUERED; ③ GLOSSY LACQUERED; ④ METAL LACQUERED; ⑤ VENEREED WOOD; ⑥ HPL; ⑦ RESIN CEMENT

**AIRY SISTEMA | ELEMENTI A GIORNO H.35 IN METALLO LACCATO GAMMA RCR OPACO SP. 0,2 CON SCHIENA IN LEGNO**

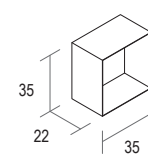
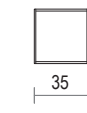
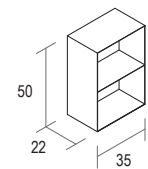
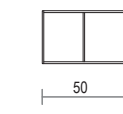
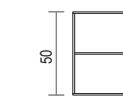

AIRY SISTEMA  
LACQUERED METAL OPEN CABINETS  
(RCR-RANGE COLORS 0.2 THICK METAL WITH  
WOODEN BACKS)

	DIMENSIONI DIMENSIONS	CODICE CODE	①	②	③ ④ ⑤ ⑥	⑦
<b>ELEMENTO A GIORNO 35X35</b> OPEN CABINET	 	P. 22 <b>17217101</b>	392,00	406,00	413,00	474,00
<b>ELEMENTO A GIORNO 50X35 REVERSIBILE</b> REVERSIBLE OPEN CABINET	  	P. 22 <b>17217107</b>	488,00	505,00	521,00	599,00

**FINITURE/FINISHES:**



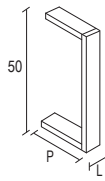
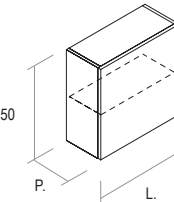
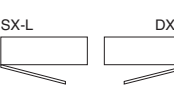

① NOBILITATO; ② LACCATO OPACO; ③ LACCATO LUCIDO; ④ LACCATO METALLO; ⑤ IMPIALLACCIATO; ⑥ HPL; ⑦ RESINA CEMENTO  
① MELAMINE; ② MATT LACQUERED; ③ GLOSSY LACQUERED; ④ METAL LACQUERED; ⑤ VENEREED WOOD; ⑥ HPL; ⑦ RESIN CEMENT

**AIRY SISTEMA | PENSILI H. 50 - SPECIFICARE IL SENSO DI APERTURA**

AIRY SISTEMA WALL UNITS H. 50 SPECIFY OPENING DIRECTION	DIMENSIONI DIMENSIONS	CODICE CODE	①	②	③ ④ ⑤ ⑥	⑦
<b>TAMPONAMENTO PENSILE H.50</b> FILLER WOODEN-STRIP FOR FOR WALL UNITS	P. 16	<b>19126014</b>	115,00	173,00	189,00	304,00
	L. 5 - 15	P. 22 <b>19126015</b>	132,00	198,00	217,00	348,00
	P. 35	<b>19126016</b>	168,00	252,00	276,00	444,00
<b>N.B. MISURA MINIMA L. 5 CM E MASSIMA L. 15 CM</b> N.B. MIN. L. 5 CM AND MAX L. 15 CM						
<b>PENSILE 1 ANTA</b> CUPBOARD W/1 DOOR	P. 16	<b>16001007</b>	174,00	196,00	245,00	357,00
	L. 15	P. 22 <b>16001008</b>	189,00	217,00	276,00	420,00
	P. 35	<b>16001009</b>	221,00	262,00	343,00	559,00
	P. 16	<b>16001010</b>	174,00	196,00	245,00	357,00
	L. 20	P. 22 <b>16001011</b>	189,00	217,00	276,00	420,00
	P. 35	<b>16001012</b>	221,00	262,00	343,00	559,00
	P. 16	<b>16001013</b>	174,00	196,00	245,00	357,00
	L. 25	P. 22 <b>16001014</b>	189,00	217,00	276,00	420,00
	P. 35	<b>16001015</b>	221,00	262,00	343,00	559,00
	P. 16	<b>16001016</b>	188,00	222,00	283,00	423,00
	L. 30	P. 22 <b>16001017</b>	207,00	249,00	322,00	496,00
	P. 35	<b>16001018</b>	245,00	302,00	400,00	655,00
	P. 16	<b>16001019</b>	188,00	222,00	283,00	423,00
	L. 35	P. 22 <b>16001020</b>	207,00	249,00	322,00	496,00
	P. 35	<b>16001021</b>	245,00	302,00	400,00	655,00
	P. 16	<b>16001022</b>	201,00	237,00	304,00	457,00
	L. 50	P. 22 <b>16001023</b>	221,00	266,00	346,00	542,00
	P. 35	<b>16001024</b>	267,00	330,00	439,00	731,00

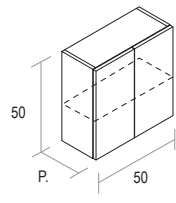
**FINITURE/FINISHES:**  
 ① NOBILITATO; ② LACCATO OPACO; ③ LACCATO LUCIDO; ④ LACCATO METALLO; ⑤ IMPIALLACCIATO; ⑥ HPL; ⑦ RESINA CEMENTO  
 ① MELAMINE; ② MATT LACQUERED; ③ GLOSSY LACQUERED; ④ METAL LACQUERED; ⑤ VENEREED WOOD; ⑥ HPL; ⑦ RESIN CEMENT

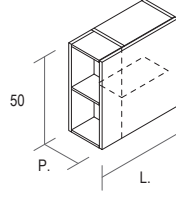
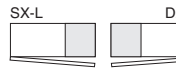
**AIRY SISTEMA | PENSILI H. 50 - SPECIFICARE IL SENSO DI APERTURA**



AIRY SISTEMA WALL UNITS H. 50 SPECIFY OPENING DIRECTION	DIMENSIONI DIMENSIONS	CODICE CODE	①	②	③ ④ ⑤ ⑥	⑦
<b>PENSILE 2 ANTE</b> CUPBOARD W/2 DOORS	P. 16	<b>16006020</b>	275,00	318,00	398,00	573,00
	L. 50	P. 22 <b>16006021</b>	292,00	343,00	437,00	658,00
	P. 35	<b>16006022</b>	338,00	407,00	530,00	846,00
						
<b>PENSILE 1 ANTA CON VANO LATERALE A GIORNO L.15</b> 1-DOOR CUPBOARD WITH SIDE OPEN COMPARTMENT	P. 22	<b>16301010D</b>	238,00	297,00	368,00	542,00*
	L. 35	<b>16301010S</b>	238,00	297,00	368,00	542,00*
	P. 35	<b>16301050D</b>	276,00	350,00	446,00	701,00*
	L. 50	<b>16301050S</b>	276,00	350,00	446,00	701,00*
	P. 22	<b>16301011D</b>	270,00	355,00	446,00	665,00*
	L. 50	<b>16301011S</b>	270,00	355,00	446,00	665,00*
	P. 35	<b>16301051D</b>	322,00	414,00	539,00	890,00*
	L. 50	<b>16301051S</b>	322,00	414,00	539,00	890,00*

**\*LA VARIANTE IN FINITURA RESINA CEMENTO E' DISPONIBILE SOLO PER IL FRONTALE, MENTRE LA PARTE A GIORNO INTERNA SARA' REALIZZATA IN UN'ALTRA FINITURA DA SPECIFICARE IN FASE D'ORDINE.**

\*THE CEMENT RESIN FINISH IS AVAILABLE FOR DOORS ONLY.  
 THE FINISH OF THE SIDE OPEN-COMPARTMENT MUST BE SPECIFIED IN THE ORDER.

**FINITURE/FINISHES:**  
 ① NOBILITATO; ② LACCATO OPACO; ③ LACCATO LUCIDO; ④ LACCATO METALLO; ⑤ IMPIALLACCIATO; ⑥ HPL; ⑦ RESINA CEMENTO  
 ① MELAMINE; ② MATT LACQUERED; ③ GLOSSY LACQUERED; ④ METAL LACQUERED; ⑤ VENEREED WOOD; ⑥ HPL; ⑦ RESIN CEMENT

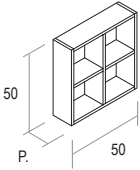
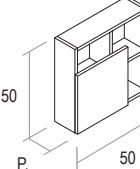
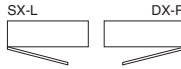
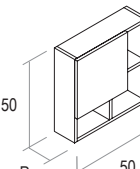
**AIRY SISTEMA | PENSILI H. 50 - SPECIFICARE IL SENSO DI APERTURA**

AIRY SISTEMA WALL UNITS H. 50 SPECIFY OPENING DIRECTION	DIMENSIONI DIMENSIONS	CODICE CODE	①	②	③ ④ ⑤ ⑥	⑦
<b>PENSILE A GIORNO</b> OPEN CABINET 	P. 14	<b>16117001</b>	163,00	255,00	342,00	-
	L. 50					
	P. 20	<b>16117002</b>	166,00	280,00	364,00	-
	L. 50					
<b>PENSILE A GIORNO CON ANTA 35X35</b> 1-DOOR CUPBOARD WITH OPEN COMPARTMENTS 	P. 16	<b>16101001</b>	240,00	353,00	461,00	546,00*
	L. 50					
	P. 22	<b>16101002</b>	242,00	376,00	483,00	570,00*
	L. 50					
<b>PENSILE A GIORNO CON ANTA 35X35</b> 1-DOOR CUPBOARD WITH OPEN COMPARTMENTS 	P. 16	<b>16101003</b>	240,00	353,00	461,00	546,00*
	L. 50					
	P. 22	<b>16101004</b>	242,00	376,00	483,00	570,00*
	L. 50					

**\*LA VARIANTE IN FINITURA RESINA CEMENTO E' DISPONIBILE SOLO PER L'ANTA. IN FASE D'ORDINE SPECIFICARE LA FINITURA DELLA STRUTTURA DEL PENSILE.**

THE CEMENT RESIN FINISH IS AVAILABLE FOR DOORS ONLY.  
THE FINISH OF THE SIDE OPEN-COMPARTMENT MUST BE SPECIFIED IN THE ORDER.

**FINITURE/FINISHES:**  
① NOBILITATO; ② LACCATO OPACO; ③ LACCATO LUCIDO; ④ LACCATO METALLO; ⑤ IMPIALLACCIATO; ⑥ HPL; ⑦ RESINA CEMENTO  
① MELAMINE; ② MATT LACQUERED; ③ GLOSSY LACQUERED; ④ METAL LACQUERED; ⑤ VENEREED WOOD; ⑥ HPL; ⑦ RESIN CEMENT

**AIRY SISTEMA | PENSILI H. 50 - SPECIFICARE IL SENSO DI APERTURA**

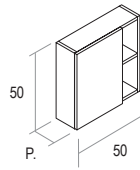
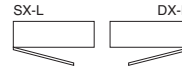
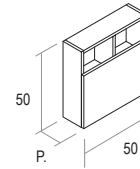
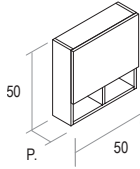
AIRY SISTEMA WALL UNITS H. 50 SPECIFY OPENING DIRECTION	DIMENSIONI DIMENSIONS	CODICE CODE	①	②	③ ④ ⑤ ⑥	⑦
<b>PENSILE A GIORNO CON ANTA 50X35</b> 1-DOOR CUPBOARD WITH OPEN COMPARTMENTS 	P. 16	<b>16101005</b>	249,00	374,00	490,00	593,00*
	L. 50					
	P. 22	<b>16101006</b>	250,00	398,00	513,00	617,00*
	L. 50					
<b>PENSILE 1 ANTA RIBALTA 35X50 CON VANI A GIORNO</b> FLIP-DOWN-DOOR CUPBOARD WITH OPEN COMPARTMENTS 	P. 16	<b>16104001</b>	299,00	419,00	534,00	637,00*
	L. 50					
	P. 22	<b>16104002</b>	300,00	441,00	557,00	661,00*
	L. 50					
<b>PENSILE CON ANTA RIALZA 35X50 CON VANI A GIORNO</b> FLIP-UP-DOOR CUPBOARD WITH OPEN COMPARTMENTS 	P. 16	<b>16105001</b>	293,00	412,00	529,00	632,00*
	L. 50					
	P. 22	<b>16105002</b>	294,00	436,00	551,00	655,00*
	L. 50					

**\*LA VARIANTE IN FINITURA RESINA CEMENTO E' DISPONIBILE SOLO PER L'ANTA. IN FASE D'ORDINE SPECIFICARE LA FINITURA DELLA STRUTTURA DEL PENSILE.**

THE CEMENT RESIN FINISH IS AVAILABLE FOR DOORS ONLY.  
THE FINISH OF THE SIDE OPEN-COMPARTMENT MUST BE SPECIFIED IN THE ORDER.

**FINITURE/FINISHES:**  
① NOBILITATO; ② LACCATO OPACO; ③ LACCATO LUCIDO; ④ LACCATO METALLO; ⑤ IMPIALLACCIATO; ⑥ HPL; ⑦ RESINA CEMENTO  
① MELAMINE; ② MATT LACQUERED; ③ GLOSSY LACQUERED; ④ METAL LACQUERED; ⑤ VENEREED WOOD; ⑥ HPL; ⑦ RESIN CEMENT

## AIRY SISTEMA | ELEMENTI A GIORNO IN LEGNO SP. 1,2

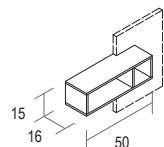
AIRY SISTEMA  
WALL UNITS H. 50ELEMENTO A GIORNO 15X50  
DA SOVRAPPORRE A  
SPECCHIERA "NARCISO"  
OPEN CABINET FOR MIRRORS "NARCISO"

DIMENSIONI DIMENSIONS	CODICE CODE	①	②	③ ④ ⑤ ⑥
P. 16	<b>17147029</b>	144,00	232,00	289,00
P. 16	<b>17147030</b> ORIZZ. C + D	103,00	190,00	253,00
	<b>17147010</b> VERT. A + B			
P. 22	<b>17147031</b> ORIZZ. C + D	109,00	217,00	273,00
	<b>17147011</b> VERT. A + B			
P. 22	<b>17147003</b>	144,00	327,00	397,00
P. 35	<b>17147004</b>	176,00	402,00	529,00

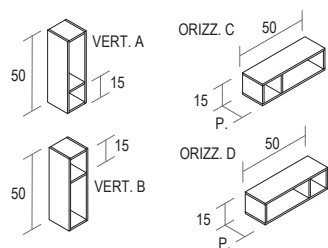
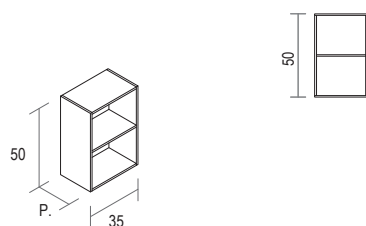
ELEMENTO A GIORNO 50X15  
OPEN CABINETELEMENTO A GIORNO 50X35  
OPEN CABINET

## AIRY SISTEMA | ELEMENTI A GIORNO IN METALLO LACC. BIANCO SP. 0,2 CON SCHIENA IN LEGNO

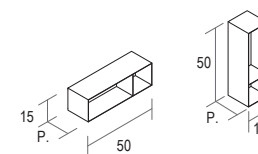
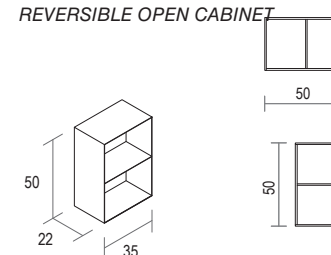
AIRY SISTEMA  
LACQUERED METAL OPEN CABINETS  
(WHITE 0.2 THICK METAL WITH WOODEN  
BACKS)ELEMENTO A GIORNO 50X15  
REVERSIBILE  
REVERSIBLE OPEN CABINETELEMENTO A GIORNO 50X35  
REVERSIBILE  
REVERSIBLE OPEN CABINET

## AIRY SISTEMA | ELEMENTI A GIORNO IN METALLO LACCATO GAMMA RCR OPACO SP. 0,2 CON SCHIENA IN LEGNO

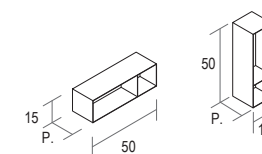
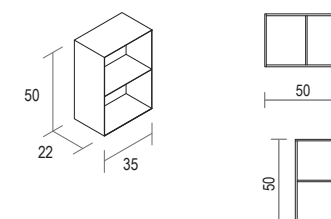





AIRY SISTEMA  
LACQUERED METAL OPEN CABINETS  
(RCR-RANGE COLORS 0.2 THICK METAL WITH  
WOODEN BACKS)ELEMENTO A GIORNO 50X15  
REVERSIBILE  
REVERSIBLE OPEN CABINETELEMENTO A GIORNO 50X35  
REVERSIBILE  
REVERSIBLE OPEN CABINET

FINITURE/FINISHES:

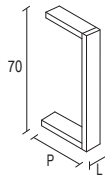
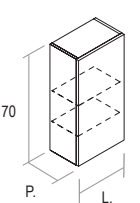
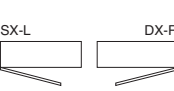
FINITURE/FINISHES:





① NOBILITATO; ② LACCATO OPACO; ③ LACCATO LUCIDO; ④ LACCATO METALLO; ⑤ IMPIALLACCIATO; ⑥ HPL  
① MELAMINE; ② MATT LACQUERED; ③ GLOSSY LACQUERED; ④ METAL LACQUERED; ⑤ VENEREED WOOD; ⑥ HPL① NOBILITATO; ② LACCATO OPACO; ③ LACCATO LUCIDO; ④ LACCATO METALLO; ⑤ IMPIALLACCIATO; ⑥ HPL; ⑦ RESINA CEMENTO  
① MELAMINE; ② MATT LACQUERED; ③ GLOSSY LACQUERED; ④ METAL LACQUERED; ⑤ VENEREED WOOD; ⑥ HPL; ⑦ RESIN CEMENT

**AIRY SISTEMA | PENSILI H. 70 - SPECIFICARE IL SENSO DI APERTURA**

AIRY SISTEMA WALL UNITS H. 70 SPECIFY OPENING DIRECTION	DIMENSIONI DIMENSIONS	CODICE CODE	①	②	③	④	⑤	⑥	⑦
<b>TAMPONAMENTO PENSILE H. 70</b> FILLER WOODEN-STRIP FOR FOR WALL UNITS	P. 16	<b>19126017</b>	143,00	215,00	235,00				378,00
	L. 5 - 15	P. 22	<b>19126018</b>	160,00	240,00	263,00			422,00
		P. 35	<b>19126019</b>	196,00	294,00	322,00			518,00
<b>N.B. MISURA MINIMA L. 5 CM E MASSIMA L. 15 CM</b> N.B. MIN. L. 5 CM AND MAX L. 15 CM									
<b>PENSILE 1 ANTA</b> CUPBOARD W/1 DOOR	P. 16	<b>16001025</b>	184,00	244,00	299,00				446,00
	L. 15	P. 22	<b>16001026</b>	202,00	272,00	338,00			528,00
		P. 35	<b>16001027</b>	239,00	333,00	423,00			704,00
	L. 20	P. 16	<b>16001028</b>	184,00	244,00	299,00			446,00
		P. 22	<b>16001029</b>	202,00	272,00	338,00			528,00
	L. 20	P. 35	<b>16001030</b>	239,00	333,00	423,00			704,00
		P. 16	<b>16001031</b>	184,00	244,00	299,00			446,00
	L. 25	P. 22	<b>16001032</b>	202,00	272,00	338,00			528,00
		P. 35	<b>16001033</b>	239,00	333,00	423,00			704,00
	L. 30	P. 16	<b>16001034</b>	201,00	281,00	348,00			530,00
		P. 22	<b>16001035</b>	222,00	314,00	395,00			622,00
	L. 30	P. 35	<b>16001036</b>	265,00	382,00	490,00			818,00
		P. 16	<b>16001037</b>	201,00	281,00	348,00			530,00
	L. 35	P. 22	<b>16001038</b>	222,00	314,00	395,00			622,00
		P. 35	<b>16001039</b>	265,00	382,00	490,00			818,00
	L. 50	P. 16	<b>16001040</b>	231,00	341,00	428,00			659,00
		P. 22	<b>16001041</b>	251,00	376,00	477,00			762,00
P. 35	<b>16001042</b>	302,00	456,00	588,00			989,00		

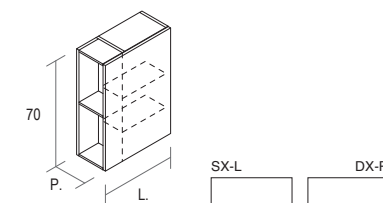
**FINITURE/FINISHES:**  
 ① NOBILITATO; ② LACCATO OPACO; ③ LACCATO LUCIDO; ④ LACCATO METALLO; ⑤ IMPIALLACCIATO; ⑥ HPL; ⑦ RESINA CEMENTO  
 ① MELAMINE; ② MATT LACQUERED; ③ GLOSSY LACQUERED; ④ METAL LACQUERED; ⑤ VENEREED WOOD; ⑥ HPL; ⑦ RESIN CEMENT

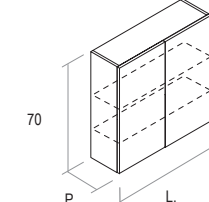
**AIRY SISTEMA | PENSILI H. 70**

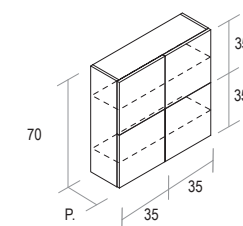
AIRY SISTEMA WALL UNITS H. 70	DIMENSIONI DIMENSIONS	CODICE CODE	①	②	③	④	⑤	⑥	⑦
<b>PENSILE 1 ANTA CON VANO LATERALE A GIORNO L.15</b> 1-DOOR CUPBOARD WITH SIDE OPEN COMPARTMENT	P. 22	<b>16301012D</b>	271,00	381,00	462,00				683,00*
		<b>16301012S</b>	271,00	381,00	462,00				683,00*
	L. 35	P. 35	<b>16301055D</b>	314,00	449,00	557,00			879,00*
		<b>16301055S</b>	314,00	449,00	557,00				879,00*
	P. 22	L. 50	<b>16301013D</b>	311,00	462,00	566,00			840,00*
			<b>16301013S</b>	311,00	462,00	566,00			840,00*
	P. 35	<b>16301056D</b>	365,00	529,00	668,00			1.106,00*	
		<b>16301056S</b>	365,00	529,00	668,00			1.106,00*	
 <b>ILLUMINAZIONE INTERNA DISPONIBILE</b> INTERNAL LIGHTING AVAILABLE									
<b>PENSILE 2 ANTE</b> CUPBOARD W/2 DOORS	P. 16	<b>16006001</b>	284,00	392,00	480,00				708,00
	L. 50	P. 22	<b>16006002</b>	308,00	429,00	529,00			812,00
		P. 35	<b>16006003</b>	358,00	507,00	641,00			1.038,00
 <b>ILLUMINAZIONE INTERNA DISPONIBILE</b> INTERNAL LIGHTING AVAILABLE	P. 16	<b>16006004</b>	326,00	472,00	586,00			882,00	
		L. 70	P. 22	<b>16006005</b>	351,00	515,00	644,00		
P. 35	<b>16006006</b>		412,00	611,00	777,00			1.271,00	
<b>PENSILE 4 ANTE</b> CUPBOARD W/4 DOORS	P. 16	<b>16020001</b>	429,00	570,00	683,00				974,00
	L. 70	P. 22	<b>16020002</b>	457,00	614,00	743,00			1.097,00
		P. 35	<b>16020003</b>	518,00	709,00	876,00			1.364,00

**\*LA VARIANTE IN FINITURA RESINA CEMENTO E' DISPONIBILE SOLO PER IL FRONTALE, MENTRE LA PARTE A GIORNO INTERNA SARA' REALIZZATA IN UN'ALTRA FINITURA DA SPECIFICARE IN FASE D'ORDINE.**

*\*THE CEMENT RESIN FINISH IS AVAILABLE FOR DOORS ONLY.  
 THE FINISH OF THE SIDE OPEN-COMPARTMENT MUST BE SPECIFIED IN THE ORDER.*

**FINITURE/FINISHES:**  
 ① NOBILITATO; ② LACCATO OPACO; ③ LACCATO LUCIDO; ④ LACCATO METALLO; ⑤ IMPIALLACCIATO; ⑥ HPL; ⑦ RESINA CEMENTO  
 ① MELAMINE; ② MATT LACQUERED; ③ GLOSSY LACQUERED; ④ METAL LACQUERED; ⑤ VENEREED WOOD; ⑥ HPL; ⑦ RESIN CEMENT

**AIRY SISTEMA | ELEMENTI A GIORNO H. 70 IN LEGNO SP. 1,2**

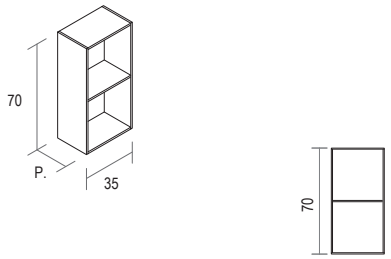
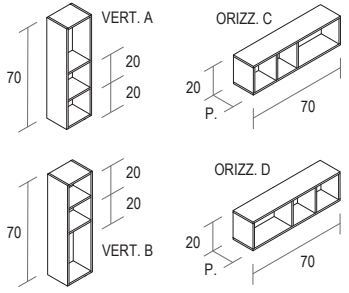
AIRY SISTEMA WALL UNITS H. 70		DIMENSIONI DIMENSIONS	CODICE CODE	①	②	③ ④ ⑤ ⑥
<b>ELEMENTO A GIORNO 70X35</b> OPEN CABINET 	P. 22	<b>17147005</b>	169,00	382,00	472,00	
	P. 35	<b>17147006</b>	205,00	516,00	633,00	
<b>ELEMENTO A GIORNO 70X20</b> OPEN CABINET 	P. 16	<b>17147032</b> VERT. A + B	134,00	271,00	357,00	
		<b>17147012</b> ORIZZ. C + D				
	P. 22	<b>17147033</b> VERT. A + B	147,00	335,00	433,00	
		<b>17147013</b> ORIZZ. C + D				

**FINITURE/FINISHES:**  
 ① NOBILITATO; ② LACCATO OPACO; ③ LACCATO LUCIDO; ④ LACCATO METALLO; ⑤ IMPIALLACCIATO; ⑥ HPL  
 ⑦ MELAMINE; ⑧ MATT LACQUERED; ⑨ GLOSSY LACQUERED; ⑩ METAL LACQUERED; ⑪ VENEREED WOOD; ⑫ HPL

**AIRY SISTEMA | ELEMENTI A GIORNO H. 70 IN METALLO LACC. BIANCO SP. 0,2 CON SCHIENA IN LEGNO**

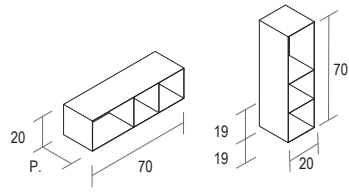
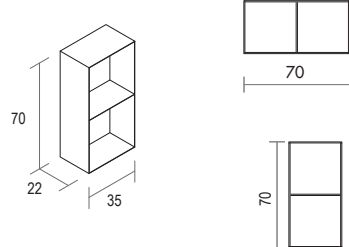
AIRY SISTEMA LACQUERED METAL OPEN CABINETS (WHITE 0.2 THICK METAL WITH WOODEN BACKS)		DIMENSIONI DIMENSIONS	CODICE CODE	①	②	③ ④ ⑤ ⑥	⑦
<b>ELEMENTO A GIORNO 70X20 REVERSIBILE</b> REVERSIBLE OPEN CABINET 	P. 22	<b>17217020</b>	371,00	385,00	398,00	437,00	
	<b>ELEMENTO A GIORNO 70X35 REVERSIBILE</b> REVERSIBLE OPEN CABINET 	P. 22	<b>17217009</b>	373,00	401,00	418,00	523,00

**AIRY SISTEMA | ELEMENTI A GIORNO H. 70 IN METALLO LACCATO GAMMA RCR OPACO SP. 0,2 CON SCHIENA IN LEGNO**

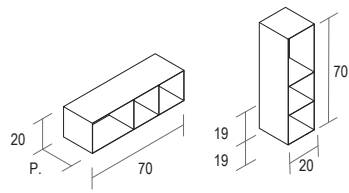
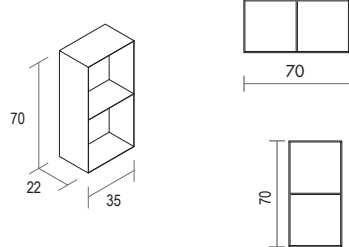
AIRY SISTEMA LACQUERED METAL OPEN CABINETS (RCR-RANGE COLORS 0.2 THICK METAL WITH WOODEN BACKS)		DIMENSIONI DIMENSIONS	CODICE CODE	①	②	③ ④ ⑤ ⑥	⑦
<b>ELEMENTO A GIORNO 70X20 REVERSIBILE</b> REVERSIBLE OPEN CABINET 	P. 22	<b>17217120</b>	515,00	527,00	540,00	586,00	
	<b>ELEMENTO A GIORNO 70X35 REVERSIBILE</b> REVERSIBLE OPEN CABINET 	P. 22	<b>17217109</b>	532,00	560,00	577,00	687,00

**FINITURE/FINISHES:**  
 ① NOBILITATO; ② LACCATO OPACO; ③ LACCATO LUCIDO; ④ LACCATO METALLO; ⑤ IMPIALLACCIATO; ⑥ HPL; ⑦ RESINA CEMENTO  
 ⑧ MELAMINE; ⑨ MATT LACQUERED; ⑩ GLOSSY LACQUERED; ⑪ METAL LACQUERED; ⑫ VENEREED WOOD; ⑬ HPL; ⑭ RESIN CEMENT

**AIRY SISTEMA | PENSILI H. 80 - SPECIFICARE IL SENSO DI APERTURA**

AIRY SISTEMA WALL UNITS H. 80 SPECIFY OPENING DIRECTION	DIMENSIONI DIMENSIONS	CODICE CODE	①	②	③ ④ ⑤ ⑥	⑦	
<b>TAMPONAMENTO PENSILE H.80</b> FILLER WOODEN-STRIP FOR FOR WALL UNITS	P. 16	<b>19126020</b>	157,00	236,00	258,00	415,00	
	L. 5 - 15	P. 22	<b>19126021</b>	174,00	261,00	286,00	459,00
		P. 35	<b>19126022</b>	210,00	315,00	345,00	555,00
<b>PENSILE 1 ANTA</b> CUPBOARD W/1 DOOR	P. 16	<b>16001080</b>	239,00	325,00	400,00	601,00	
	L. 25	P. 22	<b>16001081</b>	262,00	362,00	451,00	709,00
		P. 35	<b>16001082</b>	308,00	439,00	560,00	939,00
	L. 35	P. 16	<b>16001083</b>	260,00	373,00	464,00	712,00
		P. 22	<b>16001084</b>	286,00	414,00	522,00	830,00
		P. 35	<b>16001085</b>	341,00	502,00	646,00	1.083,00
	L. 50	P. 16	<b>16001086</b>	295,00	452,00	567,00	881,00
		P. 22	<b>16001087</b>	322,00	496,00	630,00	1.010,00
		P. 35	<b>16001088</b>	386,00	595,00	769,00	1.295,00

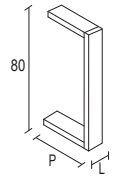

**N.B. MISURA MINIMA L. 5 CM E MASSIMA L. 15 CM**  
N.B. MIN. L. 5 CM AND MAX L. 15 CM

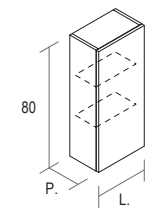

**ILLUMINAZIONE INTERNA DISPONIBILE**  
INTERNAL LIGHTING AVAILABLE

**AIRY SISTEMA | PENSILI H. 80 - SPECIFICARE IL SENSO DI APERTURA**

AIRY SISTEMA WALL UNITS H. 80	DIMENSIONI DIMENSIONS	CODICE CODE	①	②	③ ④ ⑤ ⑥	⑦	
<b>PENSILE 1 ANTA CON VANO LATERALE A GIORNO L.15</b> 1-DOOR CUPBOARD WITH SIDE OPEN COMPARTMENT	P. 22	<b>16301020D</b>	354,00	502,00	615,00	911,00*	
		<b>16301020S</b>	354,00	502,00	615,00	911,00*	
	L. 35	P. 35	<b>16301060D</b>	409,00	590,00	739,00	1.164,00*
			<b>16301060S</b>	409,00	590,00	739,00	1.164,00*
	L. 50	P. 22	<b>16301021D</b>	409,00	612,00	757,00	1.119,00*
			<b>16301021S</b>	409,00	612,00	757,00	1.119,00*
		P. 35	<b>16301061D</b>	473,00	689,00	878,00	1.449,00*
			<b>16301061S</b>	473,00	689,00	878,00	1.449,00*
	<b>PENSILE 2 ANTE</b> CUPBOARD W/2 DOORS	P. 16	<b>16006030</b>	363,00	513,00	630,00	939,00
		L. 50	P. 22	<b>16006031</b>	390,00	557,00	692,00
P. 35			<b>16006032</b>	452,00	658,00	833,00	1.353,00
L. 70		P. 16	<b>16006033</b>	413,00	621,00	772,00	1.168,00
		P. 22	<b>16006034</b>	444,00	671,00	841,00	1.316,00
		P. 35	<b>16006035</b>	523,00	792,00	1.007,00	1.647,00

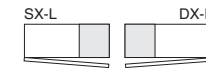
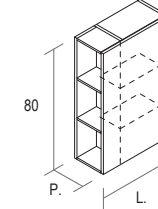

**ILLUMINAZIONE INTERNA DISPONIBILE**  
INTERNAL LIGHTING AVAILABLE

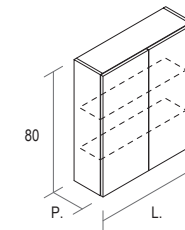







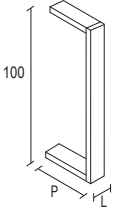
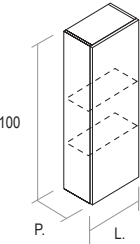

**ILLUMINAZIONE INTERNA DISPONIBILE**  
INTERNAL LIGHTING AVAILABLE

**\*LA VARIANTE IN FINITURA RESINA CEMENTO E' DISPONIBILE SOLO PER IL FRONTALE, MENTRE LA PARTE A GIORNO INTERNA SARA' REALIZZATA IN UN'ALTRA FINITURA DA SPECIFICARE IN FASE D'ORDINE.**

*\*THE CEMENT RESIN FINISH IS AVAILABLE FOR DOORS ONLY.  
THE FINISH OF THE SIDE OPEN-COMPARTMENT MUST BE SPECIFIED IN THE ORDER.*

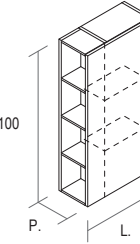

## AIRY SISTEMA | PENSILI H. 100 - SPECIFICARE IL SENSO DI APERTURA

AIRY SISTEMA WALL UNITS H. 100 SPECIFY OPENING DIRECTION	DIMENSIONI DIMENSIONS	CODICE CODE	①	②	③ ④ ⑤ ⑥	⑦	
<b>TAMPONAMENTO PENSILE H.100</b> FILLER WOODEN-STRIP FOR FOR WALL UNITS	P. 16	<b>19126023</b>	185,00	278,00	304,00	489,00	
	L. 5 - 15	<b>19126024</b>	P. 22	202,00	303,00	332,00	533,00
	P. 35		<b>19126025</b>	238,00	357,00	391,00	629,00
<b>N.B. MISURA MINIMA L. 5 CM E MASSIMA L. 15 CM</b> N.B. MIN. L. 5 CM AND MAX L. 15 CM							
<b>PENSILE 1 ANTA</b> CUPBOARD W/1 DOOR	P. 16	<b>16001043</b>	239,00	325,00	400,00	601,00	
	L. 25	P. 22	<b>16001044</b>	262,00	362,00	451,00	709,00
		P. 35	<b>16001045</b>	308,00	439,00	560,00	939,00
	L. 35	P. 16	<b>16001046</b>	260,00	373,00	464,00	712,00
		P. 22	<b>16001047</b>	286,00	414,00	522,00	830,00
		P. 35	<b>16001048</b>	341,00	502,00	646,00	1.083,00
		P. 16	<b>16001070</b>	295,00	452,00	567,00	881,00
	L.50	P. 22	<b>16001071</b>	322,00	496,00	630,00	1.010,00
		P. 35	<b>16001072</b>	386,00	595,00	769,00	1.295,00
 <b>ILLUMINAZIONE INTERNA DISPONIBILE</b> INTERNAL LIGHTING AVAILABLE							
<b>PENSILE 1 ANTA CON VANO LATERALE A GIORNO L.15</b> 1-DOOR CUPBOARD WITH SIDE OPEN COMPARTMENT	P. 22	<b>16301014D</b>	354,00	502,00	615,00	911,00*	
	L. 35	<b>16301014S</b>	354,00	502,00	615,00	911,00*	
		P. 35	<b>16301065D</b>	412,00	593,00	741,00	1.170,00*
		<b>16301065S</b>	412,00	593,00	741,00	1.170,00*	
		P. 22	<b>16301015D</b>	409,00	612,00	757,00	1.119,00*
		<b>16301015S</b>	409,00	612,00	757,00	1.119,00*	
	L. 50	P. 35	<b>16301066D</b>	476,00	716,00	902,00	1.409,00*
		<b>16301066S</b>	476,00	716,00	902,00	1.409,00*	

\*LA VARIANTE IN FINITURA RESINA CEMENTO E' DISPONIBILE SOLO PER IL FRONTALE, MENTRE LA PARTE A GIORNO INTERNA SARA' REALIZZATA IN UN'ALTRA FINITURA DA SPECIFICARE IN FASE D'ORDINE.





\*THE CEMENT RESIN FINISH IS AVAILABLE FOR DOORS ONLY. THE FINISH OF THE SIDE OPEN-COMPARTMENT MUST BE SPECIFIED IN THE ORDER.

## FINITURE/FINISHES:

① NOBILITATO; ② LACCATO OPACO; ③ LACCATO LUCIDO; ④ LACCATO METALLO; ⑤ IMPIALLACCIATO; ⑥ HPL; ⑦ RESINA CEMENTO

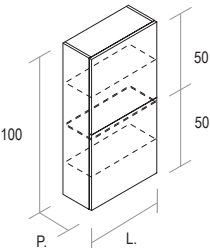
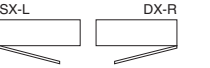
① MELAMINE; ② MATT LACQUERED; ③ GLOSSY LACQUERED; ④ METAL LACQUERED; ⑤ VENEREED WOOD; ⑥ HPL; ⑦ RESIN CEMENT

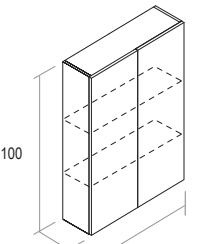
## AIRY SISTEMA | PENSILI H. 100 - SPECIFICARE IL SENSO DI APERTURA

AIRY SISTEMA WALL UNITS H. 100 SPECIFY OPENING DIRECTION	DIMENSIONI DIMENSIONS	CODICE CODE	①	②	③ ④ ⑤ ⑥	⑦	
<b>PENSILE 2 ANTE H. 50</b> CUPBOARD W/2 DOORS	P. 16	<b>16007001</b>	303,00	386,00	459,00	659,00	
	L. 25	P. 22	<b>16007002</b>	327,00	424,00	512,00	769,00
		P. 35	<b>16007003</b>	375,00	504,00	624,00	1.002,00
		P. 16	<b>16007004</b>	325,00	435,00	526,00	770,00
	L. 35	P. 22	<b>16007005</b>	354,00	480,00	587,00	890,00
		P. 35	<b>16007006</b>	412,00	571,00	713,00	1.149,00
		P. 16	<b>16007007</b>	366,00	518,00	635,00	944,00
	L. 50	P. 22	<b>16007008</b>	396,00	565,00	698,00	1.075,00
		P. 35	<b>16007009</b>	463,00	669,00	843,00	1.365,00
<b>PENSILE 2 ANTE</b> CUPBOARD W/2 DOORS	P. 16	<b>16006007</b>	363,00	513,00	630,00	939,00	
	L. 50	P. 22	<b>16006008</b>	390,00	557,00	692,00	1.069,00
		P. 35	<b>16006009</b>	452,00	658,00	833,00	1.353,00
		P. 16	<b>16006010</b>	413,00	621,00	772,00	1.168,00
	L. 70	P. 22	<b>16006011</b>	444,00	671,00	841,00	1.316,00
		P. 35	<b>16006012</b>	523,00	792,00	1.007,00	1.647,00
 <b>ILLUMINAZIONE INTERNA DISPONIBILE</b> INTERNAL LIGHTING AVAILABLE							

## FINITURE/FINISHES:

① NOBILITATO; ② LACCATO OPACO; ③ LACCATO LUCIDO; ④ LACCATO METALLO; ⑤ IMPIALLACCIATO; ⑥ HPL; ⑦ RESINA CEMENTO

① MELAMINE; ② MATT LACQUERED; ③ GLOSSY LACQUERED; ④ METAL LACQUERED; ⑤ VENEREED WOOD; ⑥ HPL; ⑦ RESIN CEMENT

## AIRY SISTEMA | ELEMENTI A GIORNO IN LEGNO SP. 1,2

AIRY SISTEMA  
OPEN WOOD ELEMENTS TH. 1.2

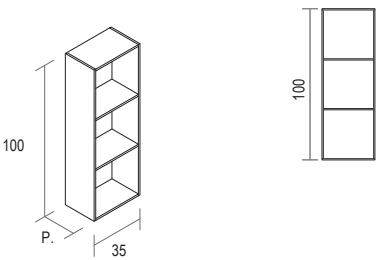
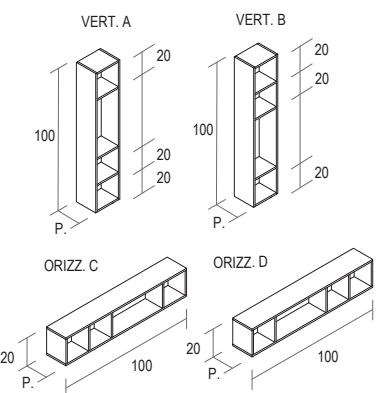
	DIMENSIONI DIMENSIONS	CODICE CODE	①	②	③ ④ ⑤ ⑥	
<b>ELEMENTO A GIORNO 100X35</b> OPEN CABINET		P. 22	17147007	216,00	496,00	622,00
		P. 35	17147008	270,00	680,00	859,00
<b>ELEMENTO A GIORNO 100X20</b> OPEN CABINET		P. 16	17147034 ORIZZ.	169,00	386,00	515,00
			17147014 VERT.			
		P. 22	17147035 ORIZZ.	191,00	429,00	570,00
			17147015 VERT.			

## FINITURE/FINISHES:

① NOBILITATO; ② LACCATO OPACO; ③ LACCATO LUCIDO; ④ LACCATO METALLO; ⑤ IMPIALLACCIATO; ⑥ HPL  
① MELAMINE; ② MATT LACQUERED; ③ GLOSSY LACQUERED; ④ METAL LACQUERED; ⑤ VENEREED WOOD; ⑥ HPL

## AIRY SISTEMA | ELEMENTI A GIORNO IN METALLO LACC. BIANCO SP. 0,2 CON SCHIENA IN LEGNO

AIRY SISTEMA  
LAQUERED METAL OPEN CABINET  
(WHITE 0,2 THICK METAL WITH WO-  
ODEN BACKS)

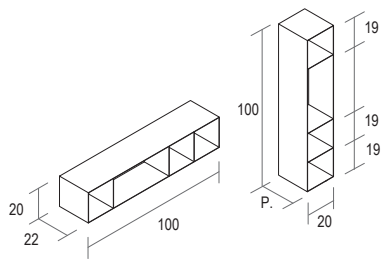
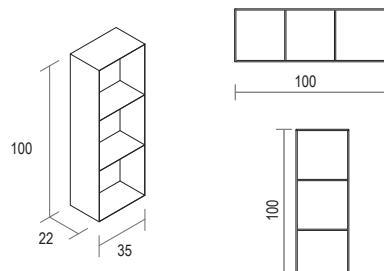
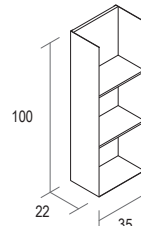
	DIMENSIONI DIMENSIONS	CODICE CODE	①	②	③ ④ ⑤ ⑥	⑦	
<b>ELEMENTO A GIORNO 100X20</b> REVERSIBILE REVERSIBLE OPEN CABINET		P. 22	17217005	420,00	439,00	459,00	505,00
<b>ELEMENTO A GIORNO 100X35</b> REVERSIBILE REVERSIBLE OPEN CABINET		P. 22	17217011	435,00	474,00	499,00	646,00
<b>ELEMENTO A GIORNO SENZA</b> COPERCHIO H. 100 L. 35 OPEN CABINET WITHOUT CEILING		P. 22	17217018	414,00	467,00	530,00	768,00

## FINITURE/FINISHES:

① NOBILITATO; ② LACCATO OPACO; ③ LACCATO LUCIDO; ④ LACCATO METALLO; ⑤ IMPIALLACCIATO; ⑥ HPL; ⑦ RESINA CEMENTO  
① MELAMINE; ② MATT LACQUERED; ③ GLOSSY LACQUERED; ④ METAL LACQUERED; ⑤ VENEREED WOOD; ⑥ HPL; ⑦ RESIN CEMENT

**AIRY SISTEMA | ELEMENTI A GIORNO H.100** IN METALLO LACCATO GAMMA RCR OPACO SP. 0,2 CON SCHIENA IN LEGNO

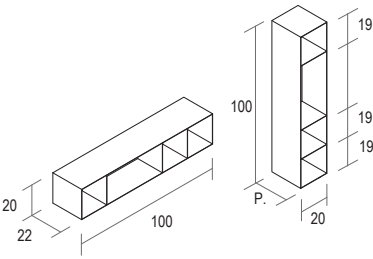
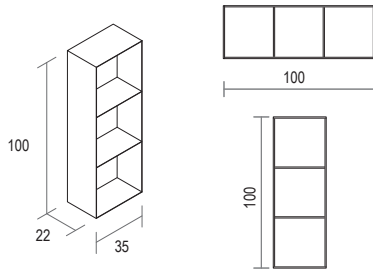
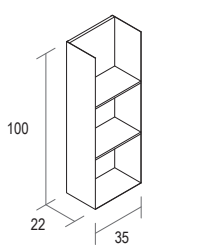
AIRY SISTEMA LAQUERED METAL OPEN CABINETS (RCR-RANGE COLORS 0,2 THICK METAL WITH WOODEN BACKS)	DIMENSIONI DIMENSIONS	CODICE CODE	①	②	③ ④ ⑤ ⑥	⑦
<b>ELEMENTO A GIORNO 100X20 REVERSIBILE</b> REVERSIBLE OPEN CABINET		P. 22 <b>17217105</b>	600,00	620,00	641,00	693,00
<b>ELEMENTO A GIORNO 100X35 REVERSIBILE</b> REVERSIBLE OPEN CABINET		P. 22 <b>17217111</b>	655,00	695,00	719,00	873,00
<b>ELEMENTO A GIORNO SENZA COPERCHIO H. 100 L. 35</b> OPEN CABINET WITHOUT CEILING		P. 22 <b>17217118</b>	567,00	620,00	682,00	926,00

**FINITURE/FINISHES:**  
 ① NOBILITATO; ② LACCATO OPACO; ③ LACCATO LUCIDO; ④ LACCATO METALLO; ⑤ IMPIALLACCIATO; ⑥ HPL; ⑦ RESINA CEMENTO  
 ① MELAMINE; ② MATT LACQUERED; ③ GLOSSY LACQUERED; ④ METAL LACQUERED; ⑤ VENEREED WOOD; ⑥ HPL; ⑦ RESIN CEMENT

**AIRY SISTEMA | COLONNE H. 150** - SPECIFICARE IL SENSO DI APERTURA

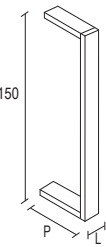
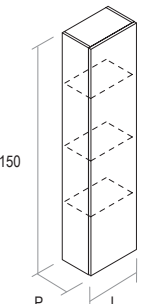
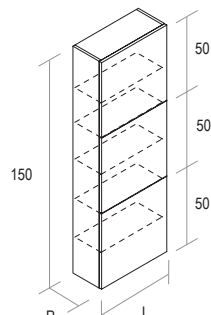
AIRY SISTEMA H. 150 COLUMNS SPECIFY OPENING DIRECTION	DIMENSIONI DIMENSIONS	CODICE CODE	①	②	③ ④ ⑤ ⑥	⑦
<b>TAMPONAMENTO COLONNA H.150</b> FILLER WOODEN-STRIP FOR WALL UNITS		P. 16 <b>19126026</b>	255,00	383,00	419,00	674,00
	L. 5 - 15 P. 22 <b>19126027</b>	272,00	408,00	447,00	718,00	
<b>N.B. MISURA MINIMA L. 5 CM E MASSIMA L. 15 CM</b> N.B. MIN. L. 5 CM AND MAX L. 15 CM	P. 35 <b>19126028</b>	308,00	462,00	506,00	814,00	
<b>COLONNA 1 ANTA</b> COLUMN W/1 DOOR		P. 16 <b>16001049</b>	304,00	436,00	528,00	839,00
	L. 25 P. 22 <b>16001050</b>	336,00	489,00	598,00	992,00	
	P. 35 <b>16001051</b>	401,00	598,00	750,00	1.318,00	
	L. 35 P. 16 <b>16001052</b>	333,00	507,00	619,00	996,00	
	P. 22 <b>16001053</b>	370,00	566,00	697,00	1.160,00	
	P. 35 <b>16001054</b>	442,00	687,00	860,00	1.510,00	
	P. 16 <b>16001073</b>	381,00	620,00	761,00	1.236,00	
	L. 50 P. 22 <b>16001074</b>	419,00	681,00	843,00	1.411,00	
	P. 35 <b>16001075</b>	502,00	816,00	1.025,00	1.794,00	
<b>COLONNA 3 ANTE H.50 DX-SX</b> COLUMN W/3 DOORS R-L		P. 16 <b>16024007</b>	423,00	560,00	655,00	1.002,00
	L. 25 P. 22 <b>16024001</b>	442,00	592,00	697,00	1.090,00	
	P. 35 <b>16024002</b>	508,00	703,00	849,00	1.417,00	
	L. 35 P. 16 <b>16024008</b>	441,00	611,00	719,00	1.094,00	
	P. 22 <b>16024003</b>	483,00	674,00	801,00	1.261,00	
	P. 35 <b>16024004</b>	559,00	799,00	967,00	1.614,00	
	P. 16 <b>16024009</b>	497,00	728,00	867,00	1.337,00	
	L.50 P. 22 <b>16024005</b>	537,00	791,00	952,00	1.515,00	
	P. 35 <b>16024006</b>	627,00	933,00	1.139,00	1.904,00	

**FINITURE/FINISHES:**  
 ① NOBILITATO; ② LACCATO OPACO; ③ LACCATO LUCIDO; ④ LACCATO METALLO; ⑤ IMPIALLACCIATO; ⑥ HPL; ⑦ RESINA CEMENTO  
 ① MELAMINE; ② MATT LACQUERED; ③ GLOSSY LACQUERED; ④ METAL LACQUERED; ⑤ VENEREED WOOD; ⑥ HPL; ⑦ RESIN CEMENT

## AIRY SISTEMA | COLONNE H. 150 - SPECIFICARE IL SENSO DI APERTURA

AIRY SISTEMA H. 150 COLUMNS SPECIFY OPENING DIRECTION	DIMENSIONI DIMENSIONS	CODICE CODE	①	②	③ ④ ⑤ ⑥	⑦
<b>COLONNA 2 ANTE</b> COLUMN W/2 DOORS	P. 16	<b>16006017</b>	462,00	692,00	834,00	1.303,00
	L. 50 P. 22	<b>16006013</b>	499,00	753,00	916,00	1.479,00
	P. 35	<b>16006014</b>	583,00	888,00	1.097,00	1.861,00
	P. 16	<b>16006018</b>	527,00	843,00	1.024,00	1.622,00
	L. 70 P. 22	<b>16006015</b>	567,00	910,00	1.113,00	1.817,00
	P. 35	<b>16006016</b>	672,00	1.071,00	1.326,00	2.250,00
<b>COLONNA 1 ANTA CON VANO LATERALE A GIORNO L.15</b> 1-DOOR CUPBOARD WITH SIDE OPEN COMPARTMENT	P. 22	<b>16301016D</b>	469,00	692,00	833,00	1.277,00*
	L. 35 P. 22	<b>16301016S</b>	469,00	692,00	833,00	1.277,00*
	P. 35	<b>16301070D</b>	541,00	813,00	996,00	1.627,00*
	L. 35 P. 35	<b>16301070S</b>	541,00	813,00	996,00	1.627,00*
	P. 22	<b>16301017D</b>	544,00	843,00	1.023,00	1.562,00*
	L. 50 P. 22	<b>16301017S</b>	544,00	843,00	1.023,00	1.562,00*
	P. 35	<b>16301071D</b>	624,00	948,00	1.178,00	2.010,00*
	L. 50 P. 35	<b>16301071S</b>	624,00	948,00	1.178,00	2.010,00*

\*LA VARIANTE IN FINITURA RESINA CEMENTO E' DISPONIBILE SOLO PER IL FRONTALE, MENTRE LA PARTE A GIORNO INTERNA SARA' REALIZZATA IN UN'ALTRA FINITURA DA SPECIFICARE IN FASE D'ORDINE.

\*THE CEMENT RESIN FINISH IS AVAILABLE FOR DOORS ONLY.

THE FINISH OF THE SIDE OPEN-COMPARTMENT MUST BE SPECIFIED IN THE ORDER.

## FINITURE/FINISHES:

① NOBILITATO; ② LACCATO OPACO; ③ LACCATO LUCIDO; ④ LACCATO METALLO; ⑤ IMPIALLACCIATO; ⑥ HPL; ⑦ RESINA CEMENTO

① MELAMINE; ② MATT LACQUERED; ③ GLOSSY LACQUERED; ④ METAL LACQUERED; ⑤ VENEREED WOOD; ⑥ HPL; ⑦ RESIN CEMENT

## AIRY SISTEMA | COLONNE H. 170 - SPECIFICARE IL SENSO DI APERTURA

AIRY SISTEMA H. 170 COLUMNS SPECIFY OPENING DIRECTION	DIMENSIONI DIMENSIONS	CODICE CODE	①	②	③ ④ ⑤ ⑥	⑦
<b>TAMPONAMENTO COLONNA H.170</b> FILLER WOODEN-STRIP FOR FOR WALL UNITS	P. 16	<b>19126029</b>	283,00	425,00	465,00	748,00
	L. 5 - 15 P. 22	<b>19126030</b>	300,00	450,00	493,00	792,00
	P. 35	<b>19126031</b>	336,00	504,00	552,00	888,00
<b>COLONNA 1 ANTA</b> COLUMN W/1 DOOR	P. 16	<b>16001100</b>	355,00	504,00	605,00	955,00
	L. 25 P. 22	<b>16001101</b>	390,00	561,00	683,00	1.125,00
	P. 35	<b>16001102</b>	458,00	681,00	849,00	1.486,00
	P. 16	<b>16001103</b>	382,00	581,00	704,00	1.128,00
	L. 35 P. 22	<b>16001104</b>	426,00	648,00	792,00	1.313,00
	P. 35	<b>16001105</b>	506,00	781,00	975,00	1.701,00
	P. 16	<b>16001106</b>	436,00	706,00	862,00	1.393,00
	L. 50 P. 22	<b>16001107</b>	477,00	773,00	952,00	1.587,00
	P. 35	<b>16001108</b>	571,00	926,00	1.156,00	2.013,00
	<b>COLONNA 1 ANTA H.120 1 ANTA DX-SX H.50</b> COLUMN W/2 DOORS (H.120+50)	P. 16	<b>16007020</b>	398,00	545,00	646,00
L. 25 P. 22		<b>16007021</b>	433,00	603,00	724,00	1.165,00
P. 35		<b>16007022</b>	501,00	721,00	889,00	1.526,00
P. 16		<b>16007023</b>	428,00	622,00	745,00	1.167,00
L. 35 P. 22		<b>16007024</b>	471,00	690,00	835,00	1.352,00
P. 35		<b>16007025</b>	553,00	823,00	1.015,00	1.740,00
P. 16		<b>16007026</b>	484,00	748,00	905,00	1.435,00
L. 50 P. 22		<b>16007027</b>	524,00	816,00	997,00	1.628,00
P. 35		<b>16007028</b>	620,00	969,00	1.199,00	2.053,00

## FINITURE/FINISHES:

① NOBILITATO; ② LACCATO OPACO; ③ LACCATO LUCIDO; ④ LACCATO METALLO; ⑤ IMPIALLACCIATO; ⑥ HPL; ⑦ RESINA CEMENTO

① MELAMINE; ② MATT LACQUERED; ③ GLOSSY LACQUERED; ④ METAL LACQUERED; ⑤ VENEREED WOOD; ⑥ HPL; ⑦ RESIN CEMENT

**AIRY SISTEMA | COLONNE H. 170 - SPECIFICARE IL SENSO DI APERTURA**

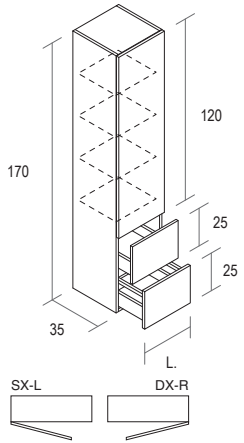
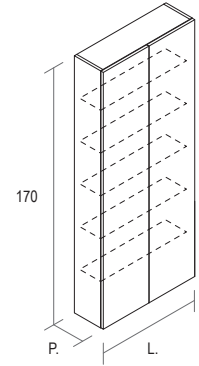
AIRY SISTEMA H. 170 COLUMNS SPECIFY OPENING DIRECTION	DIMENSIONI DIMENSIONS		CODICE CODE	①	②	③ ④ ⑤ ⑥	⑦
<b>COLONNA 1 ANTA H.120 2 CASSETTI H.25</b> COLUMN W/1 DOOR AND 2 DRAWERS 	L. 25	P. 35	<b>16042001</b>	740,00	963,00	1.111,00	1.754,00
	L. 35	P. 35	<b>16042002</b>	795,00	1.069,00	1.244,00	1.972,00
	L. 50	P. 35	<b>16042003</b>	874,00	1.224,00	1.437,00	2.297,00
<b>COLONNA 2 ANTE</b> COLUMN W/2 DOORS 		P. 16	<b>16006050</b>	518,00	780,00	937,00	1.463,00
	L. 50	P. 22	<b>16006051</b>	559,00	846,00	1.029,00	1.655,00
		P. 35	<b>16006052</b>	654,00	999,00	1.231,00	2.081,00
		P. 16	<b>16006053</b>	597,00	954,00	1.156,00	1.827,00
	L. 70	P. 22	<b>16006054</b>	642,00	1.029,00	1.254,00	2.037,00
	P. 35	<b>16006055</b>	763,00	1.212,00	1.491,00	2.519,00	

**ILLUMINAZIONE INTERNA DISPONIBILE**  
INTERNAL LIGHTING AVAILABLE

**FINITURE/FINISHES:**  
 ① NOBILITATO; ② LACCATO OPACO; ③ LACCATO LUCIDO; ④ LACCATO METALLO; ⑤ IMPIALLACCIATO; ⑥ HPL; ⑦ RESINA CEMENTO  
 ① MELAMINE; ② MATT LACQUERED; ③ GLOSSY LACQUERED; ④ METAL LACQUERED; ⑤ VENEREED WOOD; ⑥ HPL; ⑦ RESIN CEMENT

**AIRY SISTEMA | COLONNE H. 170 - SPECIFICARE IL SENSO DI APERTURA**

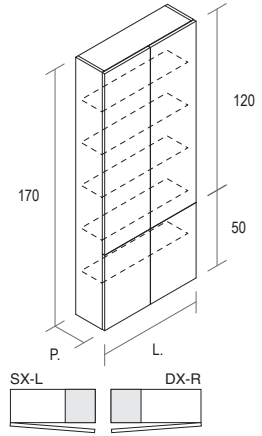
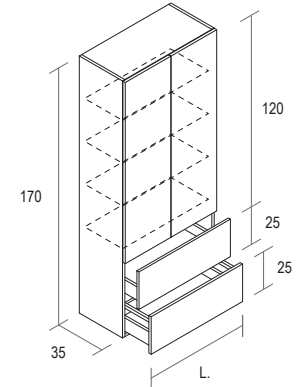
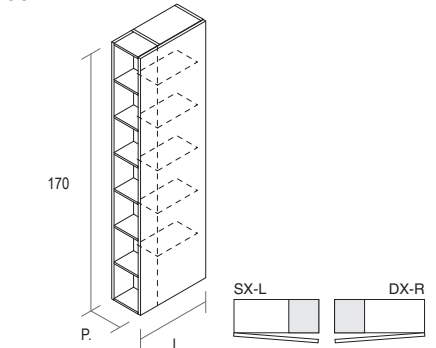
AIRY SISTEMA H. 170 COLUMNS SPECIFY OPENING DIRECTION	DIMENSIONI DIMENSIONS		CODICE CODE	①	②	③ ④ ⑤ ⑥	⑦
<b>COLONNA 2 ANTE H.120 2 ANTE H.50</b> COLUMN W/2 + 2 DOORS (H. 120 + 50) 		P. 16	<b>16020010</b>	604,00	862,00	1.016,00	1.542,00
	L. 50	P. 22	<b>16020011</b>	646,00	930,00	1.107,00	1.735,00
		P. 35	<b>16020012</b>	741,00	1.081,00	1.310,00	2.160,00
		P. 16	<b>16020013</b>	686,00	1.038,00	1.238,00	1.906,00
	L. 70	P. 22	<b>16020014</b>	730,00	1.112,00	1.336,00	2.117,00
	P. 35	<b>16020015</b>	852,00	1.297,00	1.575,00	2.599,00	
<b>COLONNA 2 ANTE H.120 2 CASSETTI H.25</b> COLUMN W/2 DOORS AND 2 DRAWERS 		P. 35	<b>16043001</b>	943,00	1.287,00	1.500,00	2.355,00
	L. 50	P. 35	<b>16043001</b>	943,00	1.287,00	1.500,00	2.355,00
	L. 70	P. 35	<b>16043002</b>	1064,00	1.511,00	1.773,00	2.803,00
<b>COLONNA 1 ANTA CON VANO LATERALE A GIORNO L.15 CM</b> 1-DOOR CUPBOARD WITH SIDE OPEN COMPARTMENT 		P. 22	<b>16301025D</b>	542,00	791,00	950,00	1.446,00*
		P. 22	<b>16301025S</b>	542,00	791,00	950,00	1.446,00*
	L. 35		<b>16301072D</b>	622,00	924,00	1.133,00	1.834,00*
		P. 35	<b>16301072S</b>	622,00	924,00	1.133,00	1.834,00*
		P. 22	<b>16301026D</b>	584,00	917,00	1.117,00	1.723,00*
		P. 22	<b>16301026S</b>	584,00	917,00	1.117,00	1.723,00*
	L. 50		<b>16301073D</b>	678,00	1.070,00	1.321,00	2.149,00*
		P. 35	<b>16301073S</b>	678,00	1.070,00	1.321,00	2.149,00*





**ILLUMINAZIONE INTERNA DISPONIBILE**  
INTERNAL LIGHTING AVAILABLE

\*LA VARIANTE IN FINITURA RESINA CEMENTO E' DISPONIBILE SOLO PER IL FRONTALE, MENTRE LA PARTE A GIORNO INTERNA SARA' REALIZZATA IN UN'ALTRA FINITURA DA SPECIFICARE IN FASE D'ORDINE.

\*THE CEMENT RESIN FINISH IS AVAILABLE FOR DOORS ONLY. THE FINISH OF THE SIDE OPEN-COMPARTMENT MUST BE SPECIFIED IN THE ORDER.

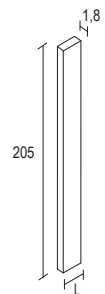
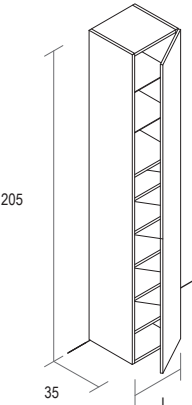

**FINITURE/FINISHES:**  
 ① NOBILITATO; ② LACCATO OPACO; ③ LACCATO LUCIDO; ④ LACCATO METALLO; ⑤ IMPIALLACCIATO; ⑥ HPL; ⑦ RESINA CEMENTO  
 ① MELAMINE; ② MATT LACQUERED; ③ GLOSSY LACQUERED; ④ METAL LACQUERED; ⑤ VENEREED WOOD; ⑥ HPL; ⑦ RESIN CEMENT

**AIRY SISTEMA | COLONNE H. 205 CON PIEDINI REGOLABILI - SPECIFICARE IL SENSO DI APERTURA**

AIRY SISTEMA FLOOR-STANDING COLUMNS H. 205 WITH ADJUSTABLE FEET SPECIFY OPENING DIRECTION	DIMENSIONI DIMENSIONS	CODICE CODE	①	②	③ ④ ⑤ ⑥	⑦
<b>TAMPONAMENTO COLONNA H.205</b> FILLER WOODEN-STRIP FOR FOR WALL UNITS						
	L. 5 - 15	<b>19126032</b>	287,00	431,00	472,00	759,00
<b>N.B. MISURA MINIMA L. 5 CM E MASSIMA L. 15 CM</b> N.B. MIN. L. 5 CM AND MAX L. 15 CM						
<b>COLONNE PORTASCARPE 1 ANTA DX-SX</b> SHOE RACK COLUMN W/1 DOOR R-L						
	L. 35 P. 35	<b>18101020</b>	565,00	838,00	1.114,00	1.890,00
		<b>K8101020 SMONTATA IN KIT</b>	565,00	838,00	1.114,00	1.890,00
	L. 50 P. 35	<b>18101021</b>	643,00	992,00	1.313,00	2.201,00
		<b>K8101021 SMONTATA IN KIT</b>	643,00	992,00	1.313,00	2.201,00
 <b>ILLUMINAZIONE INTERNA DISPONIBILE</b> INTERNAL LIGHTING AVAILABLE						
<b>COLONNE PORTASCARPE 2 ANTE</b> SHOE RACK COLUMN W/2 DOORS						
	L. 70 P. 35	<b>18106015</b>	844,00	1.284,00	1.672,00	2.703,00
		<b>K8106015 SMONTATA IN KIT</b>	844,00	1.284,00	1.672,00	2.703,00
 <b>ILLUMINAZIONE INTERNA DISPONIBILE</b> INTERNAL LIGHTING AVAILABLE						

**FINITURE/FINISHES:**  
 ① NOBILITATO; ② LACCATO OPACO; ③ LACCATO LUCIDO; ④ LACCATO METALLO; ⑤ IMPIALLACCIATO; ⑥ HPL; ⑦ RESINA CEMENTO  
 ① MELAMINE; ② MATT LACQUERED; ③ GLOSSY LACQUERED; ④ METAL LACQUERED; ⑤ VENEREED WOOD; ⑥ HPL; ⑦ RESIN CEMENT

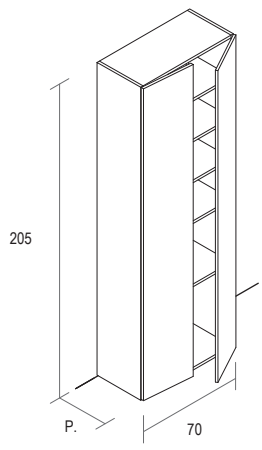
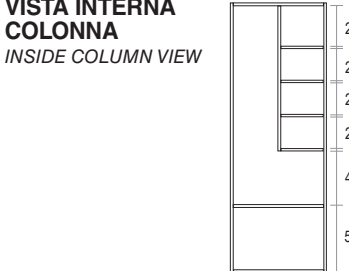
**AIRY SISTEMA | COLONNE H. 205 CON PIEDINI REGOLABILI - SPECIFICARE IL SENSO DI APERTURA**

LAUNDRY: FLOOR-STANDING COLUMNS H. 205 WITH ADJUSTABLE FEET SPECIFY OPENING DIRECTION	DIMENSIONI DIMENSIONS	CODICE CODE	①	②	③ ④ ⑤ ⑥	⑦
<b>COLONNA PORTASCOPE 2 ANTE</b> BROOM COLUMN W/2 DOORS						
	P. 35	<b>18206001</b>	814,00	1.255,00	1.643,00	2.672,00
		<b>K8206001 SMONTATA IN KIT</b>	814,00	1.255,00	1.643,00	2.672,00
	P. 46	<b>18206002</b>	926,00	1.423,00	1.884,00	3.168,00
		<b>K8206002 SMONTATA IN KIT</b>	926,00	1.423,00	1.884,00	3.168,00
 <b>ILLUMINAZIONE INTERNA DISPONIBILE</b> INTERNAL LIGHTING AVAILABLE						
	P. 51	<b>18206003</b>	926,00	1.423,00	1.884,00	3.168,00
		<b>K8206003 SMONTATA IN KIT</b>	926,00	1.423,00	1.884,00	3.168,00
	P. 62	<b>18206004</b>	1.004,00	1.543,00	2.054,00	3.519,00
		<b>K8206004 SMONTATA IN KIT</b>	1.004,00	1.543,00	2.054,00	3.519,00
	P. 70	<b>18206005</b>	1.053,00	1.619,00	2.169,00	3.762,00
		<b>K8206005 SMONTATA IN KIT</b>	1.053,00	1.619,00	2.169,00	3.762,00

**FINITURE/FINISHES:**  
 ① NOBILITATO; ② LACCATO OPACO; ③ LACCATO LUCIDO; ④ LACCATO METALLO; ⑤ IMPIALLACCIATO; ⑥ HPL; ⑦ RESINA CEMENTO  
 ① MELAMINE; ② MATT LACQUERED; ③ GLOSSY LACQUERED; ④ METAL LACQUERED; ⑤ VENEREED WOOD; ⑥ HPL; ⑦ RESIN CEMENT

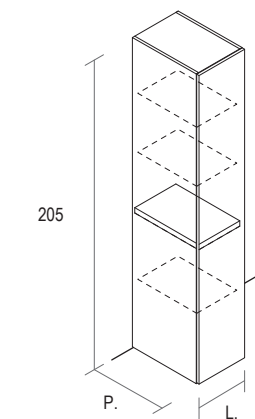
**AIRY SISTEMA | COLONNE H. 205 CON PIEDINI REGOLABILI - SPECIFICARE IL SENSO DI APERTURA**AIRY SISTEMA  
FLOOR-STANDING COLUMNS  
H. 205 WITH ADJUSTABLE FEET**COLONNA 1 ANTA**  
COLUMN W/1 DOOR
**ILLUMINAZIONE INTERNA DISPONIBILE**  
INTERNAL LIGHTING AVAILABLE

DIMENSIONI DIMENSIONS	CODICE CODE	①	②	③ ④ ⑤ ⑥	⑦
L. 35	P. 35 <b>18301001</b>	526,00	799,00	1.075,00	1.850,00
	P. 35 <b>K8301001</b> SMONTATA IN KIT	526,00	799,00	1.075,00	1.850,00
L. 35	P. 46 <b>18301002</b>	627,00	958,00	1.308,00	2.335,00
	P. 46 <b>K8301002</b> SMONTATA IN KIT	627,00	958,00	1.308,00	2.335,00
L. 35	P. 51 <b>18301003</b>	627,00	958,00	1.308,00	2.335,00
	P. 51 <b>K8301003</b> SMONTATA IN KIT	627,00	958,00	1.308,00	2.335,00
L. 35	P. 62 <b>18301004</b>	699,00	1.070,00	1.472,00	2.679,00
	P. 62 <b>K8301004</b> SMONTATA IN KIT	699,00	1.070,00	1.472,00	2.679,00
L. 35	P. 70 <b>18301005</b>	752,00	1.151,00	1.589,00	2.925,00
	P. 70 <b>K8301005</b> SMONTATA IN KIT	752,00	1.151,00	1.589,00	2.925,00
L. 50	P. 35 <b>18301006</b>	588,00	937,00	1.258,00	2.144,00
	P. 35 <b>K8301006</b> SMONTATA IN KIT	588,00	937,00	1.258,00	2.144,00
L. 50	P. 46 <b>18301007</b>	712,00	1.118,00	1.512,00	2.653,00
	P. 46 <b>K8301007</b> SMONTATA IN KIT	712,00	1.118,00	1.512,00	2.653,00
L. 50	P. 51 <b>18301008</b>	712,00	1.118,00	1.512,00	2.653,00
	P. 51 <b>K8301008</b> SMONTATA IN KIT	712,00	1.118,00	1.512,00	2.653,00
L. 50	P. 62 <b>18301009</b>	784,00	1.231,00	1.676,00	2.997,00
	P. 62 <b>K8301009</b> SMONTATA IN KIT	784,00	1.231,00	1.676,00	2.997,00
L. 50	P. 70 <b>18301010</b>	843,00	1.319,00	1.801,00	3.250,00
	P. 70 <b>K8301010</b> SMONTATA IN KIT	843,00	1.319,00	1.801,00	3.250,00

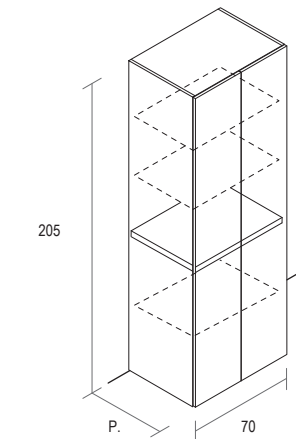
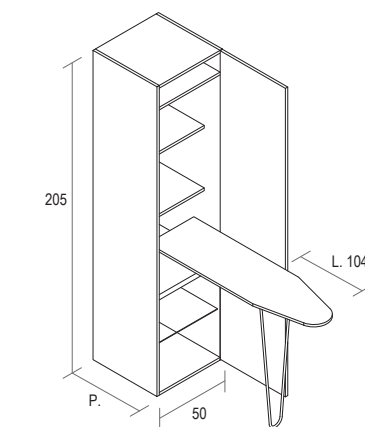
**FINITURE/FINISHES:**
 ① NOBILITATO; ② LACCATO OPACO; ③ LACCATO LUCIDO; ④ LACCATO METALLO; ⑤ IMPIALLACCIATO; ⑥ HPL; ⑦ RESINA CEMENTO  
 ① MELAMINE; ② MATT LACQUERED; ③ GLOSSY LACQUERED; ④ METAL LACQUERED; ⑤ VENEREED WOOD; ⑥ HPL; ⑦ RESIN CEMENT
**AIRY SISTEMA | COLONNE H. 205 CON PIEDINI REGOLABILI - SPECIFICARE IL SENSO DI APERTURA**AIRY SISTEMA  
FLOOR-STANDING COLUMNS  
H. 205 WITH ADJUSTABLE FEET**COLONNA 2 ANTE**  
COLUMN W/2 DOORS
**ILLUMINAZIONE INTERNA DISPONIBILE**  
INTERNAL LIGHTING AVAILABLE
**COLONNA CON ASSE DA STIRO  
ESTRAIBILE 1 ANTA 180°**  
IRONING BOARD COLUMN W/1 DOOR
**ILLUMINAZIONE INTERNA DISPONIBILE**  
INTERNAL LIGHTING AVAILABLE

DIMENSIONI DIMENSIONS	CODICE CODE	①	②	③ ④ ⑤ ⑥	⑦
L. 70	P. 35 <b>18306001</b>	773,00	1.213,00	1.601,00	2.630,00
	P. 35 <b>K8306001</b> SMONTATA IN KIT	773,00	1.213,00	1.601,00	2.630,00
L. 70	P. 46 <b>18306002</b>	920,00	1.417,00	1.878,00	3.163,00
	P. 46 <b>K8306002</b> SMONTATA IN KIT	920,00	1.417,00	1.878,00	3.163,00
L. 70	P. 51 <b>18306003</b>	920,00	1.417,00	1.878,00	3.163,00
	P. 51 <b>K8306003</b> SMONTATA IN KIT	920,00	1.417,00	1.878,00	3.163,00
L. 70	P. 62 <b>18306004</b>	1.002,00	1.539,00	2.052,00	3.516,00
	P. 62 <b>K8306004</b> SMONTATA IN KIT	1.002,00	1.539,00	2.052,00	3.516,00
L. 70	P. 70 <b>18306005</b>	1.060,00	1.627,00	2.176,00	3.769,00
	P. 70 <b>K8306005</b> SMONTATA IN KIT	1.060,00	1.627,00	2.176,00	3.769,00
L. 50	P. 35 <b>18101030</b>	1.206,00	1.555,00	1.876,00	2.783,00
	P. 35 <b>K8101030</b> SMONTATA IN KIT	1.206,00	1.555,00	1.876,00	2.783,00
L. 50	P. 46 <b>18101031</b>	1.335,00	1.741,00	2.136,00	3.297,00
	P. 46 <b>K8101031</b> SMONTATA IN KIT	1.335,00	1.741,00	2.136,00	3.297,00
L. 50	P. 51 <b>18101032</b>	1.335,00	1.741,00	2.136,00	3.297,00
	P. 51 <b>K8101032</b> SMONTATA IN KIT	1.335,00	1.741,00	2.136,00	3.297,00
L. 50	P. 62 <b>18101033</b>	1.423,00	1.870,00	2.315,00	3.657,00
	P. 62 <b>K8101033</b> SMONTATA IN KIT	1.423,00	1.870,00	2.315,00	3.657,00
L. 50	P. 70 <b>18101034</b>	1.485,00	1.961,00	2.444,00	3.914,00
	P. 70 <b>K8101034</b> SMONTATA IN KIT	1.485,00	1.961,00	2.444,00	3.914,00

**FINITURE/FINISHES:**
 ① NOBILITATO; ② LACCATO OPACO; ③ LACCATO LUCIDO; ④ LACCATO METALLO; ⑤ IMPIALLACCIATO; ⑥ HPL; ⑦ RESINA CEMENTO  
 ① MELAMINE; ② MATT LACQUERED; ③ GLOSSY LACQUERED; ④ METAL LACQUERED; ⑤ VENEREED WOOD; ⑥ HPL; ⑦ RESIN CEMENT

**AIRY SISTEMA | COLONNE H. 205** CON PIEDINI REGOLABILI (SMONTATE IN KIT) - SPECIFICARE IL SENSO DI APERTURA

AIRY SISTEMA  
FLOOR-STANDING COLUMNS  
H. 205 WITH ADJUSTABLE FEET  
(DISASSEMBLED IN KIT)

**COLONNA ANGOLARE 1 ANTA  
L. 50**  
CORNER COLUMN W/1 DOOR

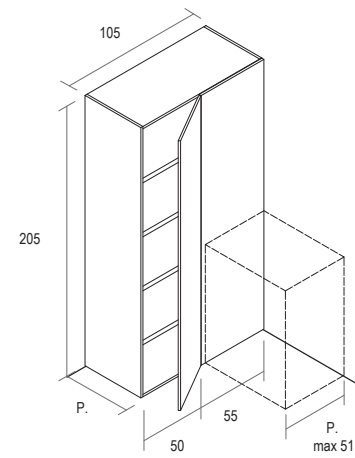

ILLUMINAZIONE INTERNA  
DISPONIBILE  
INTERNAL LIGHTING AVAILABLE



**COLONNA ANGOLARE 1 ANTA  
L. 50**  
CORNER COLUMN W/1 DOOR

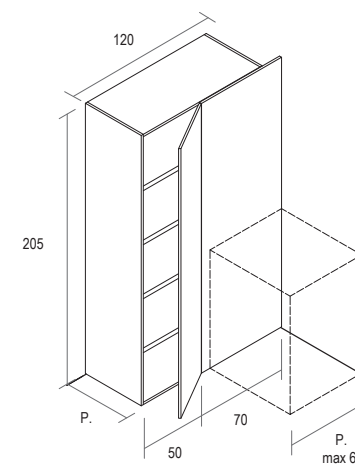

ILLUMINAZIONE INTERNA  
DISPONIBILE  
INTERNAL LIGHTING AVAILABLE



DIMENSIONI DIMENSIONS	CODICE CODE	①	②	③ ④ ⑤ ⑥	⑦
P. 35	<b>K8401001D</b>	909,00	1.515,00	2.020,00	3.298,00
	<b>K8401001S</b>	909,00	1.515,00	2.020,00	3.298,00
P. 46	<b>K8401002D</b>	1.105,00	1.768,00	2.346,00	3.881,00
	<b>K8401002S</b>	1.105,00	1.768,00	2.346,00	3.881,00
P. 51	<b>K8401003D</b>	1.105,00	1.768,00	2.346,00	3.881,00
	<b>K8401003S</b>	1.105,00	1.768,00	2.346,00	3.881,00
P. 62	<b>K8401004D</b>	1.227,00	1.931,00	2.561,00	4.278,00
	<b>K8401004S</b>	1.227,00	1.931,00	2.561,00	4.278,00
P. 70	<b>K8401005D</b>	1.265,00	1.969,00	2.599,00	4.316,00
	<b>K8401005S</b>	1.265,00	1.969,00	2.599,00	4.316,00
P. 35	<b>K8401006D</b>	939,00	1.633,00	2.168,00	3.573,00
	<b>K8401006S</b>	939,00	1.633,00	2.168,00	3.573,00
P. 46	<b>K8401007D</b>	1.136,00	1.888,00	2.495,00	4.156,00
	<b>K8401007S</b>	1.136,00	1.888,00	2.495,00	4.156,00
P. 51	<b>K8401008D</b>	1.136,00	1.888,00	2.495,00	4.156,00
	<b>K8401008S</b>	1.136,00	1.888,00	2.495,00	4.156,00
P. 62	<b>K8401009D</b>	1.259,00	2.051,00	2.710,00	4.554,00
	<b>K8401009S</b>	1.259,00	2.051,00	2.710,00	4.554,00
P. 70	<b>K8401010D</b>	1.297,00	2.089,00	2.748,00	4.593,00
	<b>K8401010S</b>	1.297,00	2.089,00	2.748,00	4.593,00

**FINITURE/FINISHES:**

① NOBILITATO; ② LACCATO OPACO; ③ LACCATO LUCIDO; ④ LACCATO METALLO; ⑤ IMPIALLACCIATO; ⑥ HPL; ⑦ RESINA CEMENTO  
① MELAMINE; ② MATT LACQUERED; ③ GLOSSY LACQUERED; ④ METAL LACQUERED; ⑤ VENEREED WOOD; ⑥ HPL; ⑦ RESIN CEMENT

**AIRY SISTEMA | COLONNE H. 205** CON PIEDINI REGOLABILI (SMONTATE IN KIT) - SPECIFICARE IL SENSO DI APERTURA

AIRY SISTEMA  
FLOOR-STANDING COLUMNS  
H. 205 WITH ADJUSTABLE FEET  
(DISASSEMBLED IN KIT)

**COLONNA ANGOLARE 1 ANTA  
L. 50**  
CORNER COLUMN W/1 DOOR

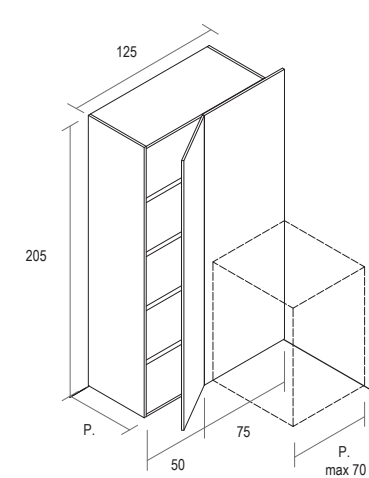

ILLUMINAZIONE INTERNA  
DISPONIBILE  
INTERNAL LIGHTING AVAILABLE



DIMENSIONI DIMENSIONS	CODICE CODE	①	②	③ ④ ⑤ ⑥	⑦
P. 35	<b>K8401011D</b>	953,00	1.672,00	2.222,00	3.665,00
	<b>K8401011S</b>	953,00	1.672,00	2.222,00	3.665,00
P. 46	<b>K8401012D</b>	1.151,00	1.927,00	2.550,00	4.248,00
	<b>K8401012S</b>	1.151,00	1.927,00	2.550,00	4.248,00
P. 51	<b>K8401013D</b>	1.151,00	1.927,00	2.550,00	4.248,00
	<b>K8401013S</b>	1.151,00	1.927,00	2.550,00	4.248,00
P. 62	<b>K8401014D</b>	1.273,00	2.090,00	2.764,00	4.644,00
	<b>K8401014S</b>	1.273,00	2.090,00	2.764,00	4.644,00
P. 70	<b>K8401015D</b>	1.313,00	2.128,00	2.803,00	4.685,00
	<b>K8401015S</b>	1.313,00	2.128,00	2.803,00	4.685,00

**FINITURE/FINISHES:**

① NOBILITATO; ② LACCATO OPACO; ③ LACCATO LUCIDO; ④ LACCATO METALLO; ⑤ IMPIALLACCIATO; ⑥ HPL; ⑦ RESINA CEMENTO  
① MELAMINE; ② MATT LACQUERED; ③ GLOSSY LACQUERED; ④ METAL LACQUERED; ⑤ VENEREED WOOD; ⑥ HPL; ⑦ RESIN CEMENT



